

CMR  **URBAN[®]**

Kent Ekipmanları / Urban Equipment

2018

Cemer[®]

Bu katalogta bulunan görseller, çizimler, bilgiler ve haklar tamamen Cemer AŞ ye aittir. Ürünler, çizimler, fotoğraflar, bilgiler, ürünle ilgili açıklamalar, grafik veya logolar gibi katalogun hiçbir bölümü Cemer AŞ nin önceden verilmiş yazılı izni olmadan üretilemez ve taklit edilemez. Aksi hareketler kanunen cezalandırılacaktır.

All rights , images, drawings and information in this catalogue are solely owned by Cemer A.Ş. Any part of this catalogue including products, drawings, photos, information, descriptions of products, graphics or logos can be reproduced or copied without a prior written consent of Cemer A.Ş. Any violence will be punished by law.



2016 yılında, İzmir Ekonomi Üniversitesi ve İzmir Ticaret Odası işbirliği ile kurulan devlet destekli Teknokent ofisinde, Cemer ailesinin parçası olan endüstriyel tasarım bölümü olarak kent mobilyaları ve ekipmanları tasarımına başladık.

Tasarım sürecini tam anlamıyla gerçekleştirme fırsatı bulduğumuz bu ofiste, gözlem, akademik araştırma, saha araştırması, pazar araştırması, fotoğraflar ve akademisyenlerin desteğiyle odak grup çalışmaları ile sürecin ilerlemesini sağladık. Türkiye'nin bir çok belediyesi ile 232 bireysel kullanıcının katıldığı anketler sayesinde süreci sonuçlandırdık ve kavram tasarımlarına başladık.

Kavram tasarımının ardından, fizibilite çalışmalarını uygulamak adına fabrika bünyesinde çalışmalarımıza devam ediyoruz. Kasım 2016'da Türkiye'de ilk tasarım merkezi ünvanını alarak prototiplerimizi yapmaya başladık.

Amacımız, Türkiye'deki Pazar eksikliğini gidermek ve A+ kalitede ürünler tasarlayarak katma değeri yüksek ürünlerin Türkiye pazarında yer almasını sağlamak ve kullanıcı ile buluşturaktır.

In 2016, as Cemer family, we started a design process for urban equipment and street furniture project in our office at İzmir Sciencepark which is founded by a collaboration of İzmir University of Economics and İzmir Chamber of Commerce.

In our office, as design team, we have the chance to experience a complete design process which includes observation, academic research, field and market research, focus group interview with help of academicians, photographing and surveys with lots of municipalities and within 232 users.

After the conceptual design process, the new concept arrives to production plants of the company for feasibility studies purposes and prototyping. Since October 2016, we have been working as Turkey's first design center.

Our aim is to make up a deficiency in our current markets we serve with A+ quality and value-added products. Designing concept products that become reality and make them available for the all markets.

İÇİNDEKİLER / INDEX



METAL SERİLERİ / METAL SERIES

Broto Serisi / Broto Series6-35
Bermuda Serisi / Bermuda Series36-47
Delta Serisi / Delta Series48-57
Edge Serisi / Edge Series58-57
Bend Serisi / Bend Series68-73

BORU SERİLERİ / TUBE SERIES

Zebra Serisi / Zebra Series74-101
Piet Serisi / Piet Series102-111

ALÜMİNYUM DÖKÜM SERİ / CAST**ALUMINUM SERIES**

71 Serisi / 71 Series112-119
-----------------------	--------------

BETON SERİLERİ / CONCRETE SERIES

Bumerang Serisi / Bumerang Series120-125
Modüler Serisi / Modular Series126-135
9040 Serisi / 9040 Series136-141
Atlas Serisi / Atlas Series142-155

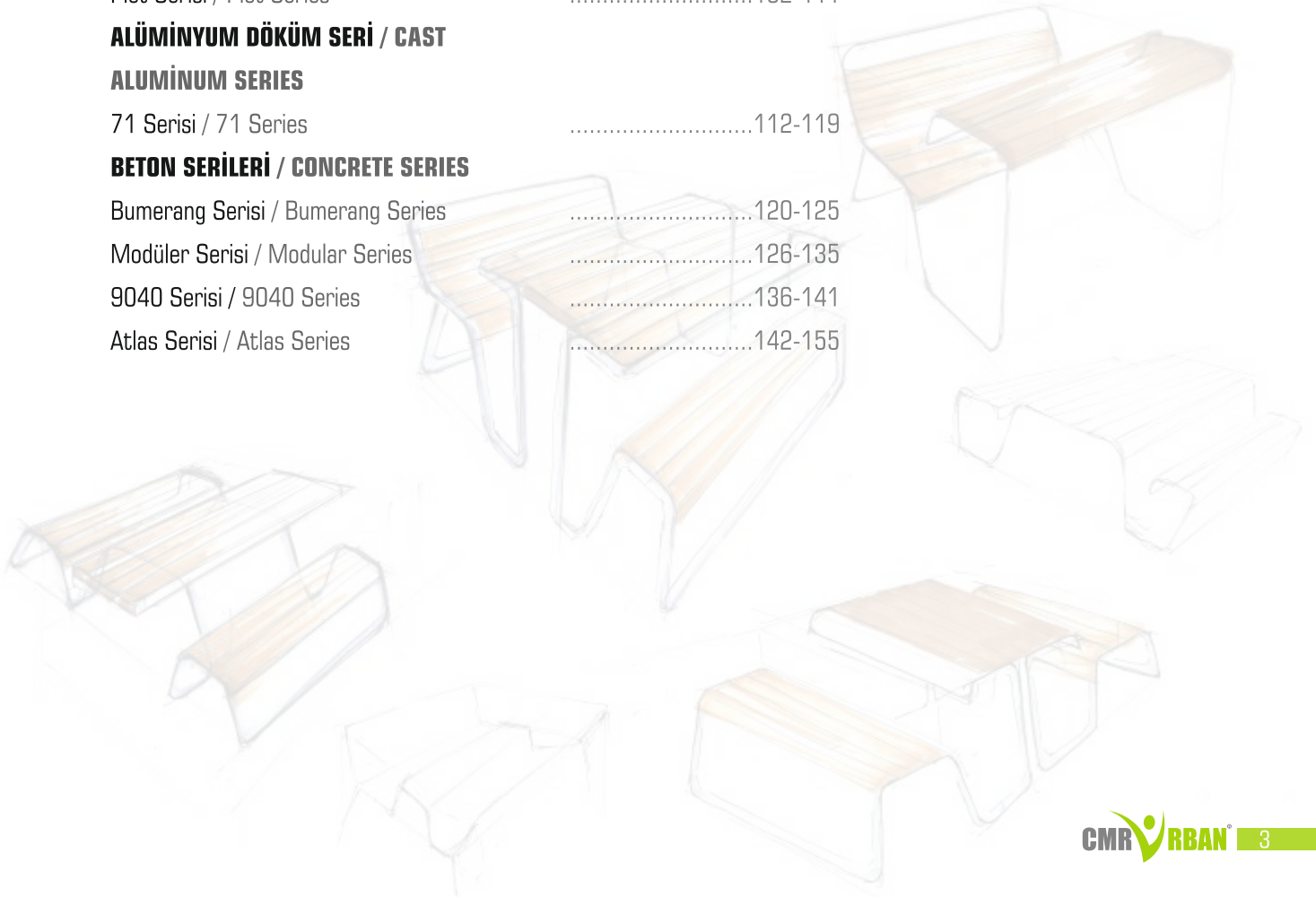

MATERYAL / MATERIAL

PREKAST / PREKAST

Prekast; beyaz çimento, silis kumu, alkali dayanımlı cam elyafı ve suyun doğru oranlarda karıştırılarak yeniden kullanılabilir kalıba dökülmesi veya döküldükten sonra kürlenene kadar şekil alabileceği bir ortamda dökülerek, monte edileceği yere taşınması işlemidir. Prekast beton üretiminde çevresel faktörler kontrol altında tutulabilir. Fabrika ortamında optimum sıcaklık, nem vb. beton için gerekli olan ortam sağlanır. Prekast beton dökümünün, standart beton dökümüne göre çok sayıda avantajı bulunmaktadır. Fabrika ortamında döküm yapıldığı için ürün kalitesi, işçilik en iyi şekilde kontrol edilebilir. Prekast malzemesi, dış etkenlere karşı oldukça dayanıklıdır. Isı ve ses geçirgenliği düşüktür. A1 sınıfı yanmaz malzemeden üretildiği için yangın yönetmeliğine uygundur.

The precast is a process in which white cement, silica sand, alkali-resistant fiber glass and water are mixed at the right proportions and poured into re-usable molds or poured in an environment where they can form before moving to the place to be mounted. Environmental factors in precast concrete production can be controlled. In the factory environment, the necessary conditions such as optimum temperature, humidity etc. is provided for concrete. Precast concrete casting has many advantages more than standard concrete casting. Product quality and workmanship can be controlled in the best way since it is cast in the factory environment. Precast material is very resistant to external factors. Heat and sound permeability is low. Since produced by non-combustible materials, it is suitable for fire control.

GRC / GRC

Glass fiber Reinforcement Concrete (Camelyaf Takviyeli Beton) GRC; silis kumu, beyaz çimento karışımı, 10-15 mm kalınlığındaki alkaliye dayanıklı cam elyafı ve polimer katkılı olarak, özel kalıplara püskürtme suretiyle dökülmesiyle üretilen üstün özellikli betondur. Gerektiği taktirde püskürtme işlemi karkas üzerine yapılarak statik ve boyutlar artırılabilir. Betondan daha dayanıklı ve hafiftir. Doğa koşullarından etkilenmez. Darbe ve aşınma mukavemetinin yüksektir. Su, ısı ve ses geçirgenliklerinin düşüktür. İstenirse boyanmaya elverişlidir. Hafif olmasından dolayı, montajı hızlı ve kolaydır. Yangına dayanıklıdır.

Glass fiber Reinforcement Concrete GRC; is a high quality concrete which is produced with the addition of silica sand, white cement mixture, 10-15 mm thick alkaline resistant glass fiber and polymer by casting and spraying into the special moulds. If necessary, the spraying process is applied on the carcass, thus the static and dimensions can be increased. This is more durable and lighter than concrete. It is not affected by the natural conditions. Impact and wear resistance is high. The permeability of water, temperature and sound is low. If desired, it is suitable for painting. Due to its light weight, it is fast and easy to install. It is fire-resistant.

ACCOYA / ACCOYA

Accoya, bilinen ahşaplardan farklı olarak, patentli üstün teknolojiyle özel bir asetilasyon işlemine tabi tutularak üretilen modifiye ahşap için verilmiş bir isimdir. Accoya, zemin üzerinde 50 yıl, zeminde veya suyun içinde 25 yıl dayanma garantisi sağlar. Çürümelere karşı direnci arttırılmış, mukavemeti yüksek bir ahşap haline getirilmiştir. Her çeşit ahşap uygulamasına (zemin kaplama, döşeme v.b.) uygun şekilde imal edilmiştir. FSC® onaylı, sürdürülebilir ve geri dönüştürülebilirdir. Diğer ahşap çeşitlerine kıyasla ahşap yalıtımı ve ısı yalıtımı çok daha gelişmiştir. Makinalı kesme ve şekillendirme işlemlerinde üretim kolaylığı sağlar.

Accoya, unlike known wood, is a modified wood, which has a patented superior technology, produced with a special acetylation process. Accoya provides resistance guarantee for 50 years on ground and 25 years under water. It is highly rot-proof and is highly resistant wood. It is manufactured in accordance with all kinds of wooden application (flooring, floor covering etc.). It is FSC® approved, sustainable and recyclable. In comparison with other types of wood, it has very improved wood insulation and heat insulation. It provides ease of production in machine cutting and forming processes.

ÇAM / PINE

1. sınıf kalitede fırınlanmış olarak kullanılan sarıçam veya karaçam beyaz çamla kıyaslandığından ortam ve hava koşullarına çok daha dayanıklıdır. Nem oranı %10-12 arasındadır. Çürük veya kaynamış budak bulunmamaktadır. Parça boyutunun 1/20 sini geçen yan ve yüzey çatlakları, renklenme, halka çatlakları, iç kabuk, çürük kovuk, böcek deliği, reçine kesesi, sulama (yalpaklık) vb. bulunmamaktadır. Üzerine her türlü ahşap uygulaması yapılması ve renklendirmeye uygundur.

The yellow pine or black pine, used as first class and oven-dried, is much more resistant to environment and weather conditions compared to white pine. Humidity rate is 10-12%. There is no decayed or joined knurl. There are no side and surface cracks, coloring, ring cracks, inner bark, decayed cavities, insect pits, resinocysts, irrigation (coves) etc. exceeding 1/20 of the piece size. It is suitable for all kinds of wooden application and coloring.

BROTO SERİSİ / BROTO SERIES

Broto, Portekizce'de tomurcuk anlamına gelir. Tasarım çizgileri bir tomurcuk filizinden esinlenilerek oluşturulan Broto kent ekipmanları serisinde ana hedef, bir filizi yalın ve minimal çizgilerle soyutlayarak ahşapları kutu gibi çevreleyen estetik bir form oluşturmaktır. Bu amaçla yenilikçi ve ergonomik kullanım alanları yaratan bu ürün grubu tasarlanmıştır.

Brot means bud in Portuguese. The main aim in the Broto urban equipment series, design lines of which have been created through the inspiration by bud sprouts, is to create aesthetical form that surrounds the wood just like a box by isolating a sprout with simple and minimal lines. For this purpose, this product group that creates innovative and ergonomic use areas has been created.

BROTO SERİSİ / BROTO SERIES



CUS 01



BROTO SIRTЛИKLI BANK / BROTO BACKREST BENCH

Sac / Sheet metal

MALZEMELER / MATERIALS

- ST 37 Galvanizli sac, AISI 316 Krom sac
/ ST 37 Galvanized Sheet metal, AISI 316 Chrome Sheet metal
- Accoya, 1. Sınıf Çam / Koyu renkli, Açık renkli ahşap
/ Accoya, 1st Class Pine / Dark wood, Light wood

YÜZEY İŞLEMLERİ / FINISHING

- Astarlama / Primer coating
- Tekstureli Füme boya 7021 / Textured Fume Colour 7021

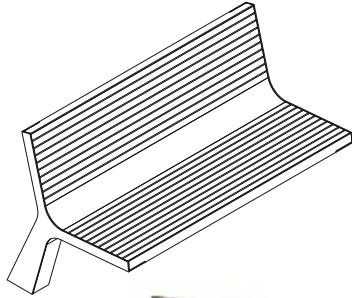
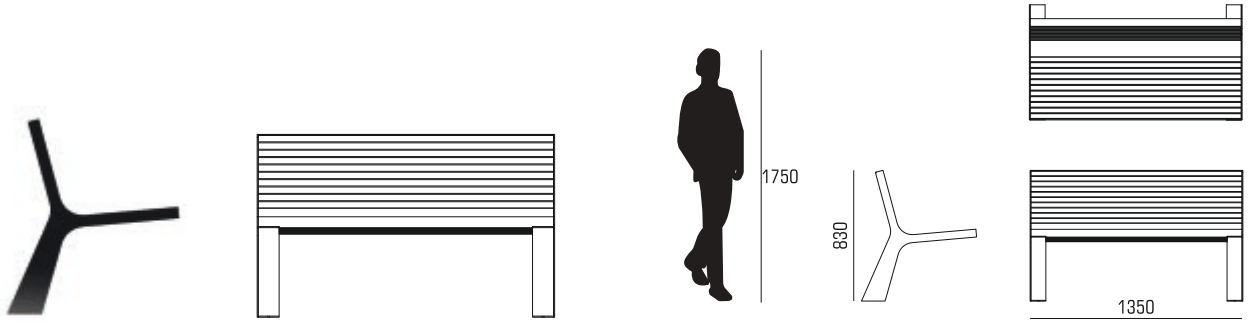

metal / metal

ahşap / wood

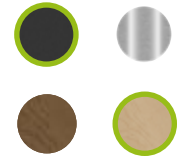



BROTO SIRTLIKSIZ BANK / BROTO STANDARD BENCH

Sac / Sheet metal

MALZEMELER / MATERIALS

- ST 37 Galvanizli sac, AISI 316 Krom sac
/ ST 37 Galvanized Sheet metal, AISI 316 Chrome Sheet metal

- Accoya, 1. Sınıf Çam / Koyu renkli, Açık renkli ahşap
/ Accoya, 1st Class Pine / Dark wood, Light wood

YÜZEY İŞLEMLERİ / FINISHING

Astarlama / Primer coating

Tekstureli Füme boya 7021 / Textured Fume Colour 7021

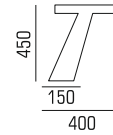
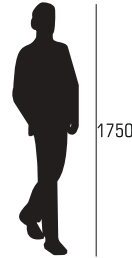

1350

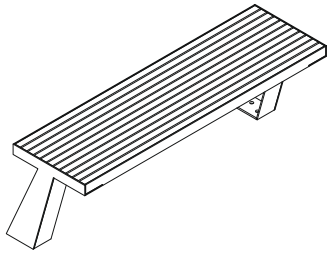

metal / metal

ahşap / wood

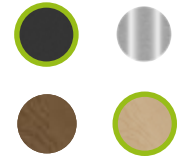



BROTO SIRTLIKSIZ BANK- 2 / BROTO STANDARD BENCH- 2

Sac / Sheet metal

MALZEMELER / MATERIALS

- ST 37 Galvanizli sac, AISI 316 Krom sac
/ ST 37 Galvanized Sheet metal, AISI 316 Chrome Sheet metal
- Accoya, 1. Sınıf Çam / Koyu renkli, Açık renkli ahşap
/ Accoya, 1st Class Pine / Dark wood, Light wood

YÜZEY İŞLEMLERİ / FINISHING

- Astarlama / Primer coating
- Tekstureli Füme boya 7021 / Textured Fume Colour 7021

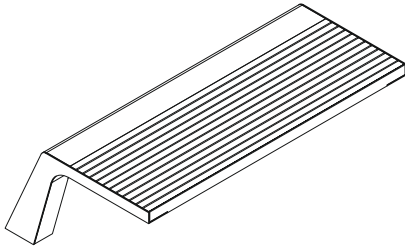
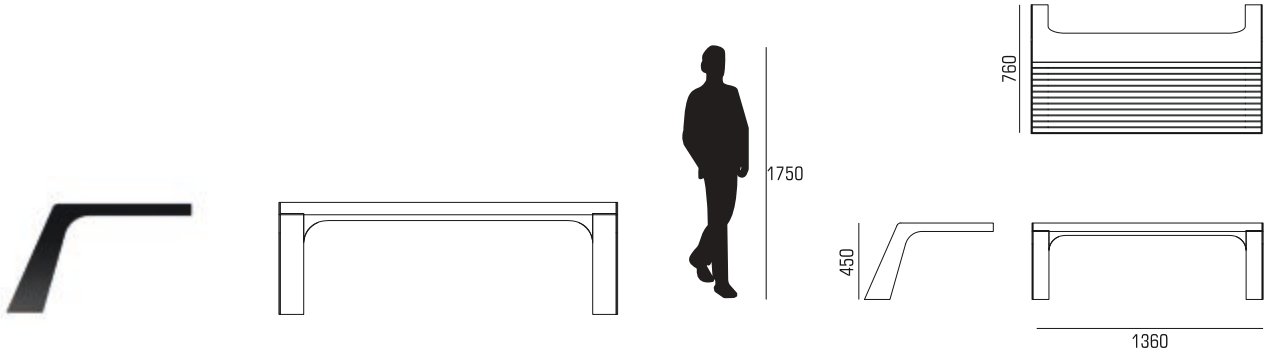

metal / metal

ahşap / wood

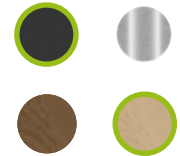

CUS 04



BROTO ŐEZLONG / BROTO SUNBED

Sac / Sheet metal

MALZEMELER / MATERIALS

- ST 37 Galvanizli sac, AISI 316 Krom sac
/ ST 37 Galvanized Sheet metal, AISI 316 Chrome Sheet metal
- Accoya, 1. Sınıf am / Koyu renkli, Aık renkli ahşap
/ Accoya, 1st Class Pine / Dark wood, Light wood

YÜZEY İŐLEMLERİ / FINISHING

- Astarlama / Primer coating
- Tekstureli Füme boya 7021 / Textured Fume Colour 7021

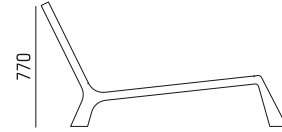
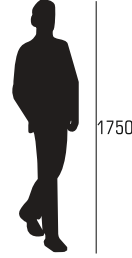
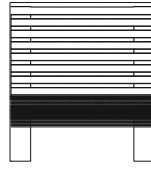

1520

700

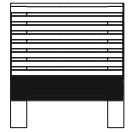
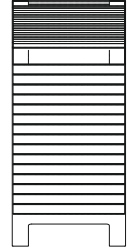

metal / metal

ahşap / wood

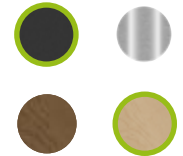

CJS 05



BROTO ŐEZLONG SEHPASI / BROTO SIDE TABLE

Sac / Sheet metal

MALZEMELER / MATERIALS

- ST 37 Galvanizli sac, AISI 316 Krom sac
/ ST 37 Galvanized Sheet metal, AISI 316 Chrome Sheet metal
- Accoya, 1. Sınıf am / Koyu renkli, Aık renkli ahřap
/ Accoya, 1st Class Pine / Dark wood, Light wood

YÜZEY İŐLEMLERİ / FINISHING

- Astarlama / Primer coating
- Tekstureli Füme boya 7021 / Textured Fume Colour 7021

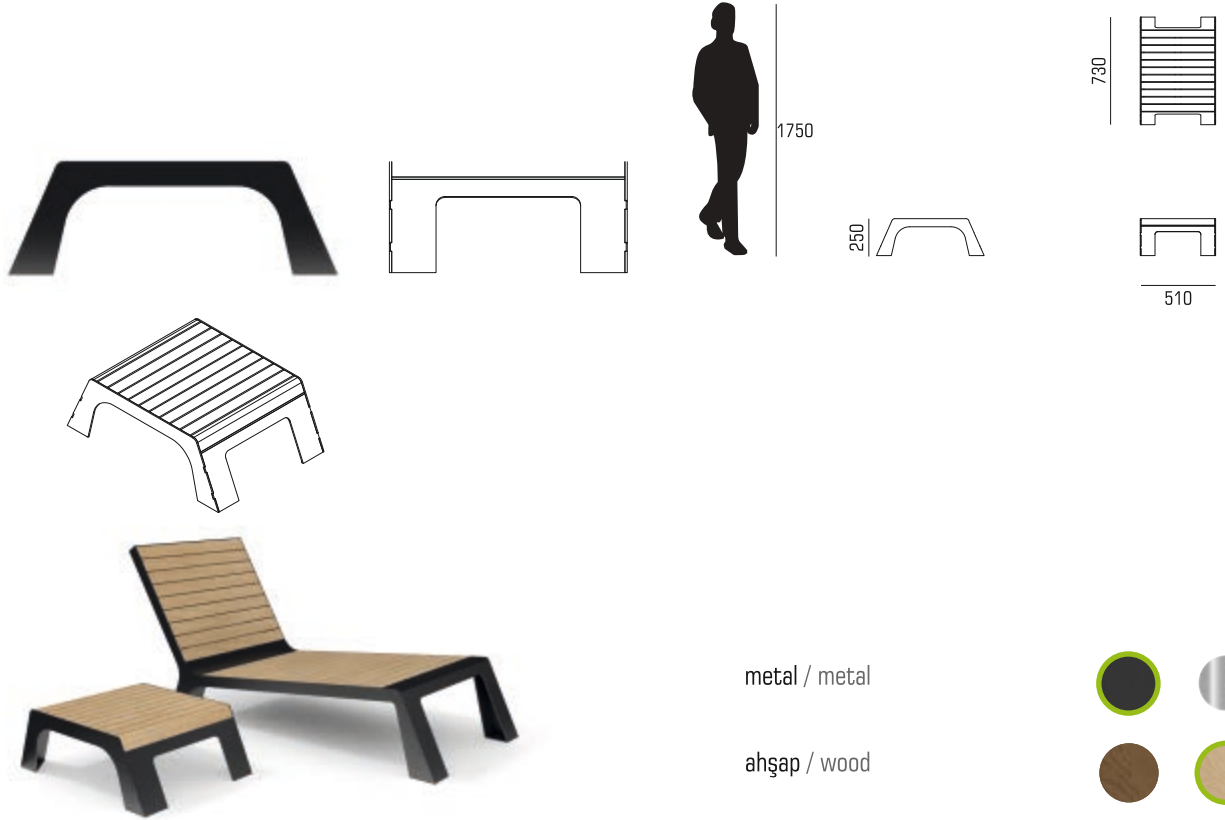



BROTO PİKNIK MASASI / BROTO PICNIC TABLE

Sac / Sheet metal

MALZEMELER / MATERIALS

- ST 37 Galvanizli sac, AISI 316 Krom sac
/ ST 37 Galvanized Sheet metal, AISI 316 Chrome Sheet metal
- Accoya, 1. Sınıf Çam / Koyu renkli, Açık renkli ahşap
/ Accoya, 1st Class Pine / Dark wood, Light wood

YÜZEY İŞLEMLERİ / FINISHING

Astarlama / Primer coating

Tekstureli Füme boya 7021 / Textured Fume Colour 7021

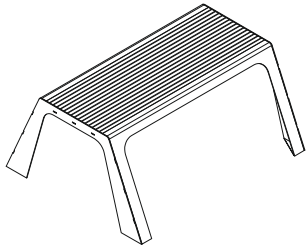
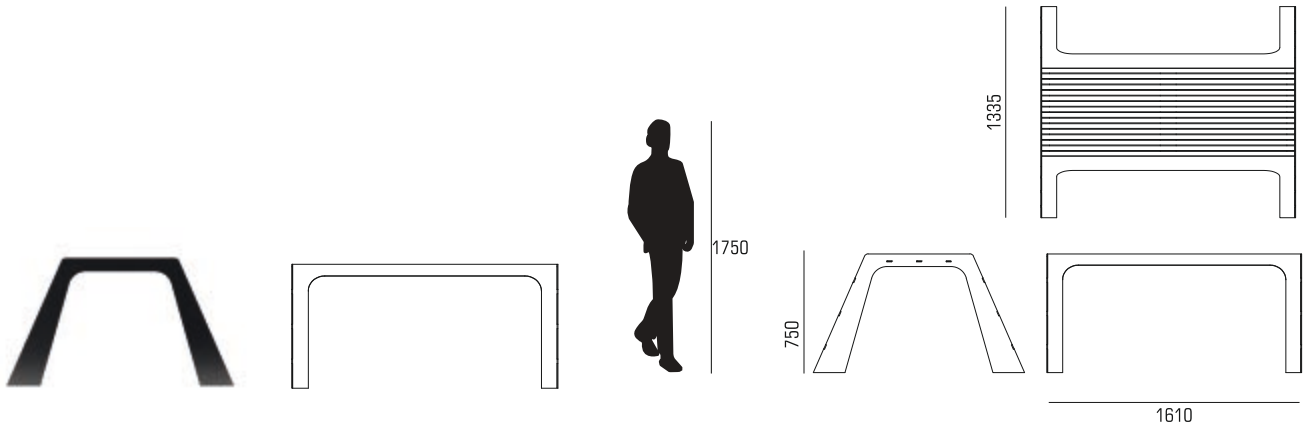

metal / metal

ahşap / wood

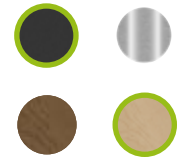



MALZEMELER / MATERIALS

- ST 37 Galvanizli sac, AISI 316 Krom sac
/ ST 37 Galvanized Sheet metal, AISI 316 Chrome Sheet metal
- Accoya, 1. Sınıf Çam / Koyu renkli, Açık renkli ahşap
/ Accoya, 1st Class Pine / Dark wood, Light wood

YÜZEY İŞLEMLERİ / FINISHING

Astarlama / Primer coating

Tekstureli Füme boya 7021 / Textured Fume Colour 7021

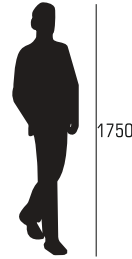

900



345

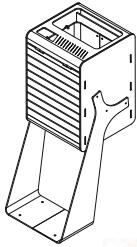

metal / metal

ahşap / wood

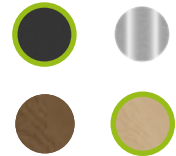



BROTO BARIYER / BROTO BARRIER

Sac / Sheet metal

MALZEMELER / MATERIALS

- ST 37 Galvanizli sac, AISI 316 Krom sac
/ ST 37 Galvanized Sheet metal, AISI 316 Chrome Sheet metal
- Accoya, 1. Sınıf Çam / Koyu renkli, Açık renkli ahşap
/ Accoya, 1st Class Pine / Dark wood, Light wood

YÜZEY İŞLEMLERİ / FINISHING

- Astarlama / Primer coating
- Tekstureli Füme boya 7021 / Textured Fume Colour 7021

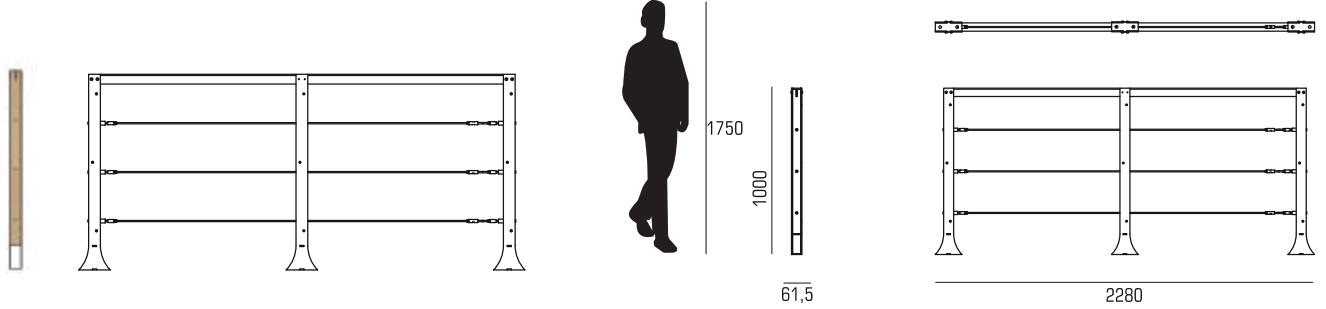

metal / metal

ahşap / wood

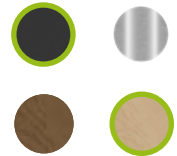



BROTO BİSİKLET PARKI / BROTO BIKE RACK

Sac / Sheet metal

MALZEMELER / MATERIALS

- ST 37 Galvanizli sac, AISI 316 Krom sac
/ ST 37 Galvanized Sheet metal, AISI 316 Chrome Sheet metal
- Accoya, 1. Sınıf Çam / Koyu renkli, Açık renkli ahşap
/ Accoya, 1st Class Pine / Dark wood, Light wood

YÜZEY İŞLEMLERİ / FINISHING

- Astarlama / Primer coating
- Tekstureli Füme boya 7021 / Textured Fume Colour 7021

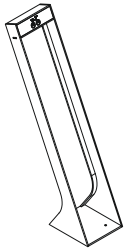
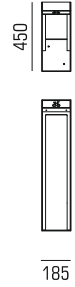
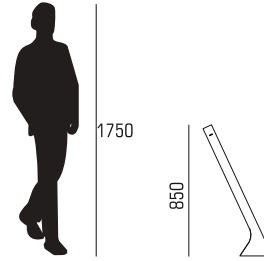

metal / metal

ahşap / wood

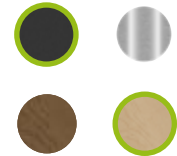

CUS 15



CUS 10



CUS 14



BROTO SINIRLANDIRICI / BROTO BOLLARD

Sac / Sheet metal

MALZEMELER / MATERIALS

- ST 37 Galvanizli sac, AISI 316 Krom sac
/ ST 37 Galvanized Sheet metal, AISI 316 Chrome Sheet metal
- Accoya, 1. Sınıf Çam / Koyu renkli, Açık renkli ahşap
/ Accoya, 1st Class Pine / Dark wood, Light wood

YÜZEY İŞLEMLERİ / FINISHING

- Astarlama / Primer coating
- Tekstureli Füme boya 7021 / Textured Fume Colour 7021

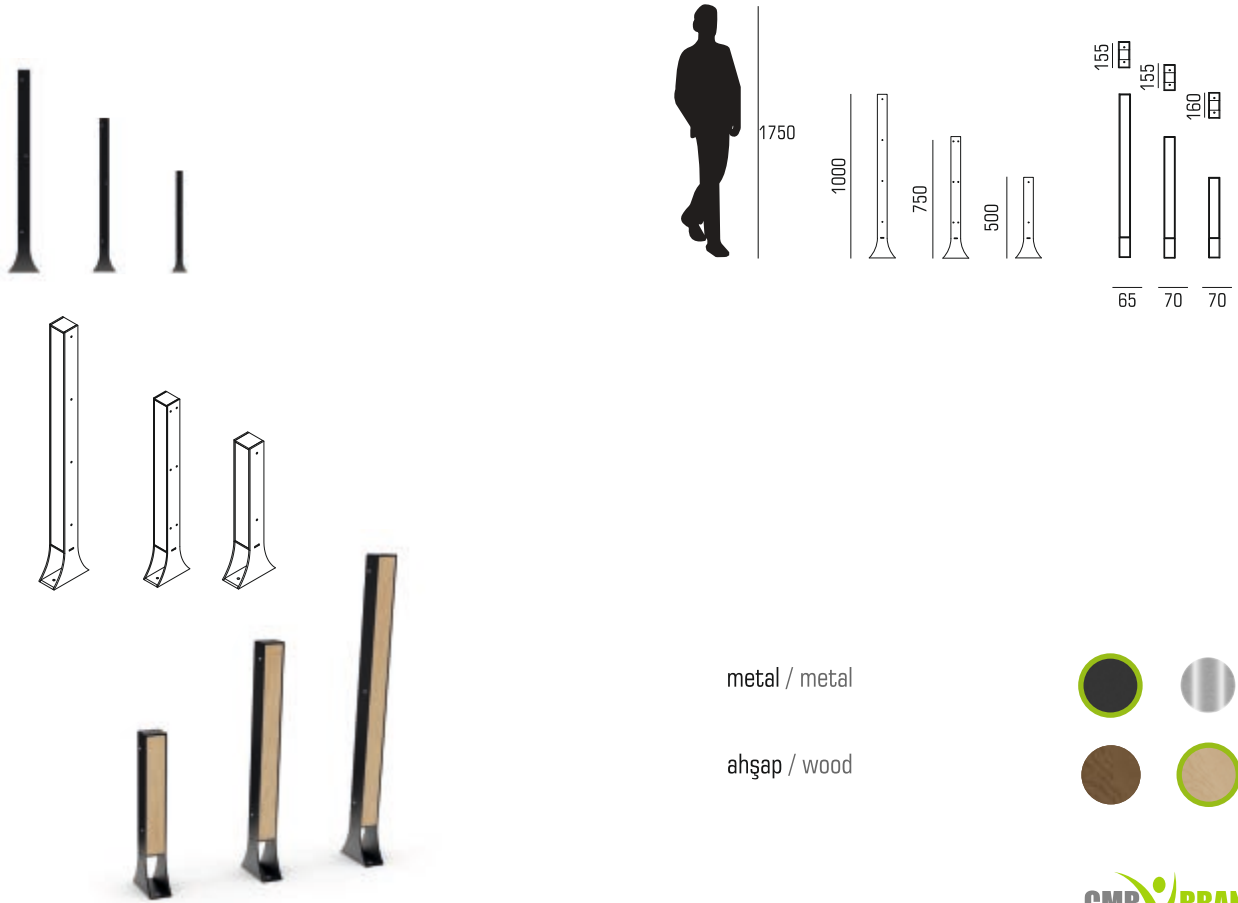

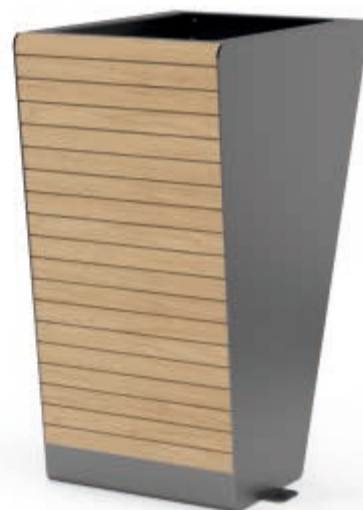

BROTO BÜYÜK SAKSI / BROTO BIG PLANTER

Sac / Sheet metal

MALZEMELER / MATERIALS

- ST 37 Galvanizli sac, AISI 316 Krom sac
/ ST 37 Galvanized Sheet metal, AISI 316 Chrome Sheet metal
- Accoya, 1. Sınıf Çam / Koyu renkli, Açık renkli ahşap
/ Accoya, 1st Class Pine / Dark wood, Light wood
- Astarlama / Primer coating
- Tekstureli Füme boya 7021 / Textured Fume Colour 7021

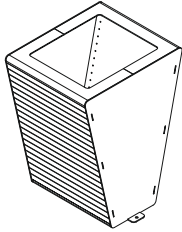
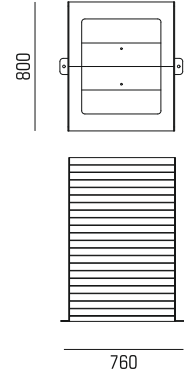
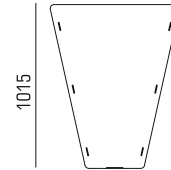
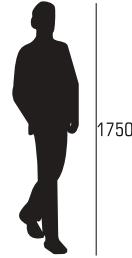
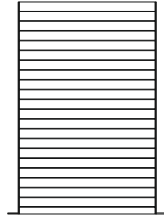

metal / metal

ahşap / wood

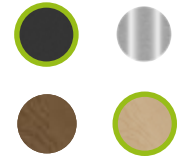



BROTO DİKDÖRTGEN SAKSI / BROTO RECTANGLE PLANTER

Sac / Sheet metal

MALZEMELER / MATERIALS

- ST 37 Galvanizli sac, AISI 316 Krom sac
/ ST 37 Galvanized Sheet metal, AISI 316 Chrome Sheet metal
- Accoya, 1. Sınıf Çam / Koyu renkli, Açık renkli ahşap
/ Accoya, 1st Class Pine / Dark wood, Light wood

YÜZEY İŞLEMLERİ / FINISHING

- Astarlama / Primer coating
- Tekstureli Füme boya 7021 / Textured Fume Colour 7021

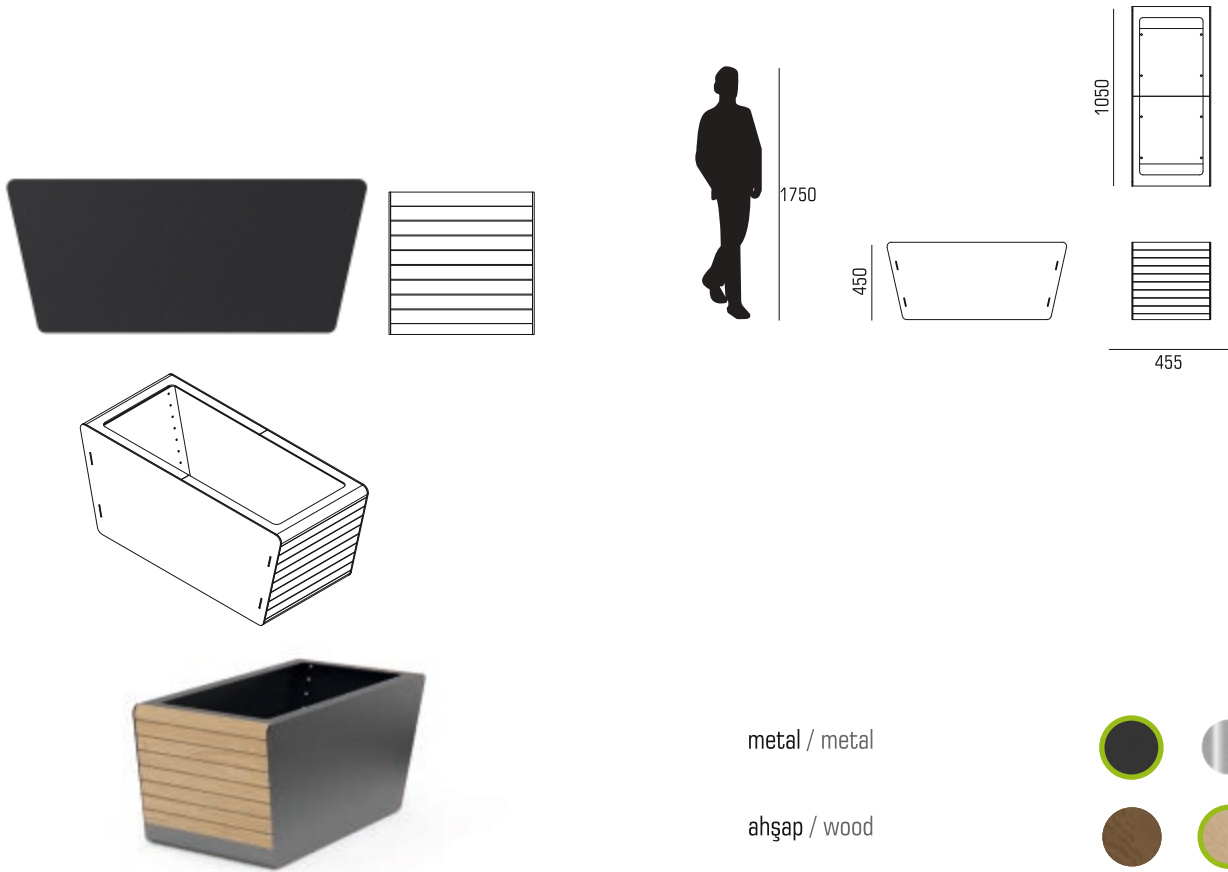



BROTO KARE SAKSI / BROTO SQUARE PLANTER

Sac / Sheet metal

MALZEMELER / MATERIALS

- ST 37 Galvanizli sac, AISI 316 Krom sac
/ ST 37 Galvanized Sheet metal, AISI 316 Chrome Sheet metal
- Accoya, 1. Sınıf Çam / Koyu renkli, Açık renkli ahşap
/ Accoya, 1st Class Pine / Dark wood, Light wood

YÜZEY İŞLEMLERİ / FINISHING

- Astarlama / Priming coat
- Tekstureli Füme boya 7021 / Textured Fume Colour 7021

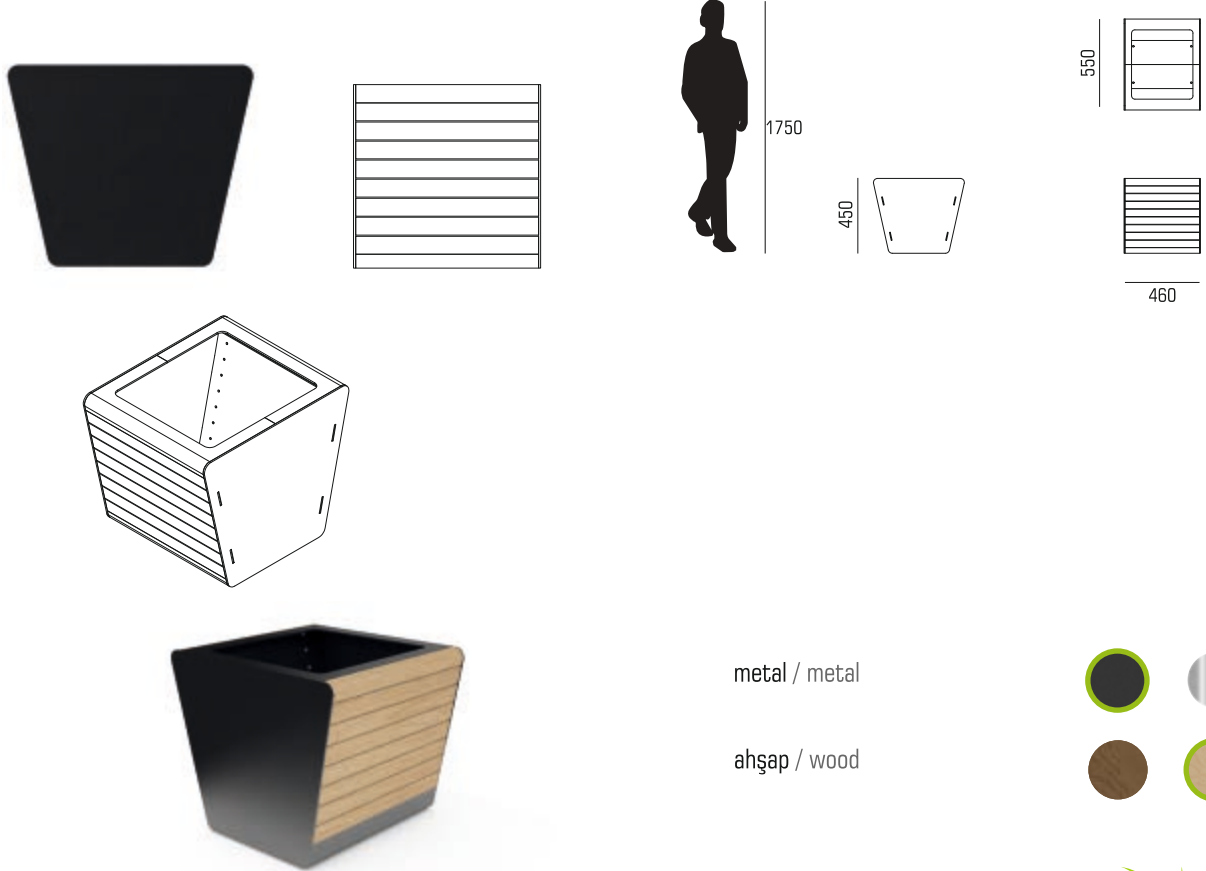



BROTO BİSTRO / BROTO BISTRO

Sac / Sheet metal

MALZEMELER / MATERIALS

- ST 37 Galvanizli sac, AISI 316 Krom sac
/ ST 37 Galvanized Sheet metal, AISI 316 Chrome Sheet metal
- Accoya, 1. Sınıf Çam / Koyu renkli, Açık renkli ahşap
/ Accoya, 1st Class Pine / Dark wood, Light wood

YÜZEY İŞLEMLERİ / FINISHING

- Astarlama / Primer coating
- Tekstureli Füme boya 7021 / Textured Fume Colour 7021

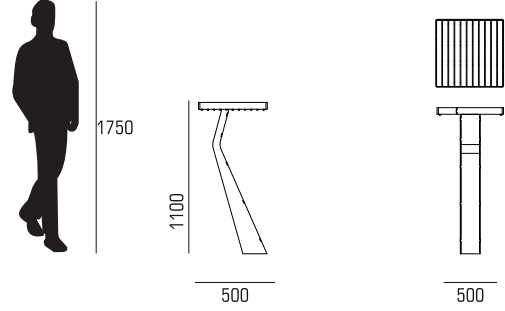

metal / metal

ahşap / wood

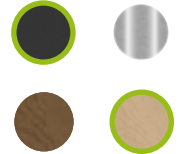

BERMUDA SERİSİ / BERMUDA SERIES

Bermuda serisi ismini Bermuda şeytan üçgeninden almaktadır. Seriyeye ait ürünlerin konstrüksiyonunda üçgen ana form olarak kullanılmıştır. İnce ve uzun ahşaplarla zarif detaylar oluşturularak, akışkan çizgileri yumuşak geçişlerle birleştiren konstrüksiyon formunu tamamlamak amaçlanmıştır.

Bermuda series takes its name from Bermuda triangle. The triangle has been used as main form in construction of the products of the series. It is aimed to complete the construction form, which combines fluid lines with smooth transitions, by creating elegant details with thin and long wood.

BERMUDA SERISI / BERMUDA SERIES



CUS 51



BERMUDA SIRTЛИKLI BANK / BERMUDA BACKREST BENCH

Sac / Sheet metal

MALZEMELER / MATERIALS

- ST 37 Galvanizli sac, AISI 316 Krom sac
/ ST 37 Galvanized Sheet metal, AISI 316 Chrome Sheet metal

- Accoya, 1. Sınıf Çam / Koyu renkli, Açık renkli ahşap
/ Accoya, 1st Class Pine / Dark wood, Light wood

YÜZEY İŞLEMLERİ / FINISHING

Astarlama / Priming coat

Tekstureli Füme boya 7021 / Textured Fume Colour 7021

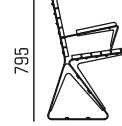
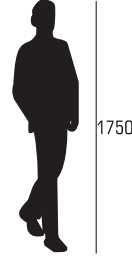

396

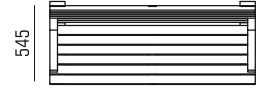

545

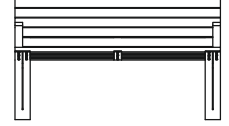

1350

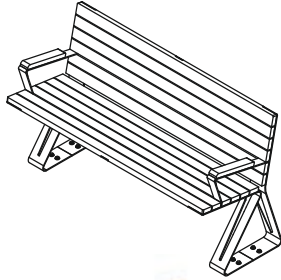

metal / metal

ahşap / wood

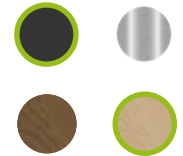



BERMUDA BİSİKLET PARKI / BERMUDA BIKE RACK

Sac / Sheet metal

MALZEMELER / MATERIALS

- ST 37 Galvanizli sac, AISI 316 Krom sac
/ ST 37 Galvanized Sheet metal, AISI 316 Chrome Sheet metal
- Accoya, 1. Sınıf Çam / Koyu renkli, Açık renkli ahşap
/ Accoya, 1st Class Pine / Dark wood, Light wood

YÜZEY İŞLEMLERİ / FINISHING

- Astarlama / Priming coat
- Tekstureli Füme boya 7021 / Textured Fume Colour 7021

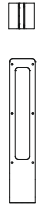
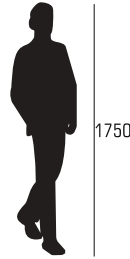

160

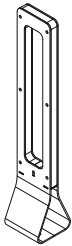

metal / metal

ahşap / wood

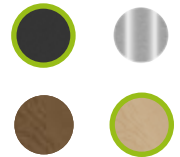



BERMUDA SINIRLANDIRICI / BERMUDA BOLLARD

Sac / Sheet metal

MALZEMELER / MATERIALS

- ST 37 Galvanizli sac, AISI 316 Krom sac
/ ST 37 Galvanized Sheet metal, AISI 316 Chrome Sheet metal
- Accoya, 1. Sınıf Çam / Koyu renkli, Açık renkli ahşap
/ Accoya, 1st Class Pine / Dark wood, Light wood

YÜZEY İŞLEMLERİ / FINISHING

- Astarlama / Primer coating
- Tekstureli Füme boya 7021 / Textured Fume Colour 7021

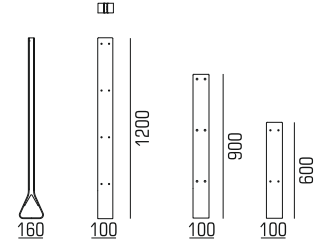
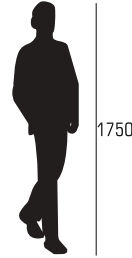

metal / metal

ahşap / wood

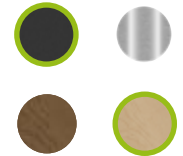



BERMUDA ÇÖP / BERMUDA LITTER BIN

Sac / Sheet metal

MALZEMELER / MATERIALS

- ST 37 Galvanizli sac, AISI 316 Krom sac
/ ST 37 Galvanized Sheet metal, AISI 316 Chrome Sheet metal
- Accoya, 1. Sınıf Çam / Koyu renkli, Açık renkli ahşap
/ Accoya, 1st Class Pine / Dark wood, Light wood

YÜZEY İŞLEMLERİ / FINISHING

- Astarlama / Primer coating
- Tekstureli Füme boya 7021 / Textured Fume Colour 7021

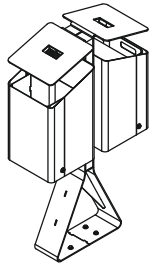
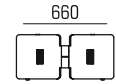
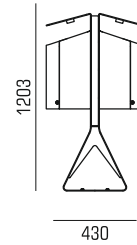

metal / metal

ahşap / wood

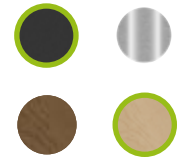



BERMUDA SAKSI / BERMUDA PLANTER

Sac / Sheet metal

MALZEMELER / MATERIALS

- ST 37 Galvanizli sac, AISI 316 Krom sac
/ ST 37 Galvanized Sheet metal, AISI 316 Chrome Sheet metal
- Accoya, 1. Sınıf Çam / Koyu renkli, Açık renkli ahşap
/ Accoya, 1st Class Pine / Dark wood, Light wood

YÜZEY İŞLEMLERİ / FINISHING

- Astarlama / Primer coating
- Tekstureli Füme boya 7021 / Textured Fume Colour 7021

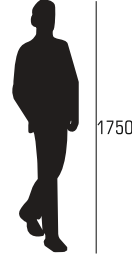

460

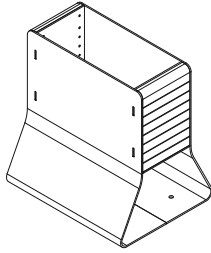

metal / metal

ahşap / wood

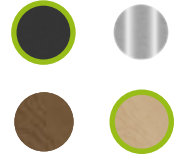

DELTA SERİSİ / DELTA SERIES

Yunan alfabesinin 4.harfi olan Delta(Δ) serisi, ismine uygun olarak üçgenlerin bir araya getirilmesi ile oluşturulan zikzaklı formu sayesinde kendiliğinden federli bir yapıya sahiptir. Bu form ile seriye ait ürünlerinin dayanıklılığının artırılması amaçlanmış, seride kullanılan ahşaplarda üretim kolaylığı sağlanmıştır.

Delta Serisinin sade ve çoğalabilen formu sayesinde farklı kombinasyonlar oluşturulabilir.

Delta(Δ) series, which is the fourth letter of the Greek alphabet, has a self-feathered structure thanks to the its zigzag form which has been created by bringing the triangles together in accordance with its name. With this form, it is aimed to increase the durability of the products of this series, and the ease of production in the wood used in this series has been ensured.

Thanks to the simple and reproducible form of the Delta series, different combinations can be created.

DELTA SERİSİ / DELTA SERIES



CUS 101



DELTA SIRTLIKSIZ BANK / DELTA STANDARD BENCH

Sac / Sheet metal

MALZEMELER / MATERIALS

- ST 37 Galvanizli sac, AISI 316 Krom sac
/ ST 37 Galvanized Sheet metal, AISI 316 Chrome Sheet metal
- Accoya, 1. Sınıf Çam / Koyu renkli, Açık renkli ahşap
/ Accoya, 1st Class Pine / Dark wood, Light wood

YÜZEY İŞLEMLERİ / FINISHING

- Astarlama / Primer coating
- Tekstureli Füme boya 7021 / Textured Fume Colour 7021

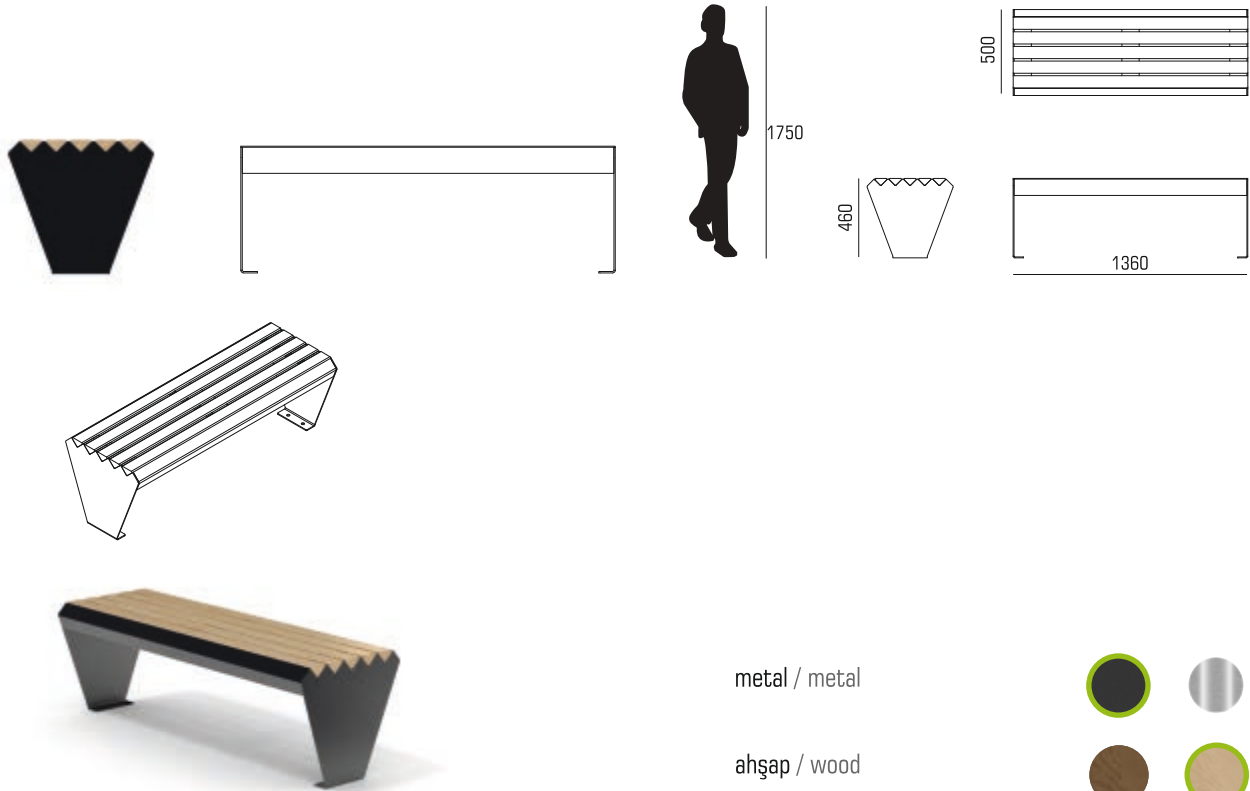



DELTA ŞEZLONG / DELTA SUNBED

Sac / Sheet metal

MALZEMELER / MATERIALS

- ST 37 Galvanizli sac, AISI 316 Krom sac
/ ST 37 Galvanized Sheet metal, AISI 316 Chrome Sheet metal
- Accoya, 1. Sınıf Çam / Koyu renkli, Açık renkli ahşap
/ Accoya, 1st Class Pine / Dark wood, Light wood

YÜZEY İŞLEMLERİ / FINISHING

- Astarlama / Primer coating
- Tekstureli Füme boya 7021 / Textured Fume Colour 7021

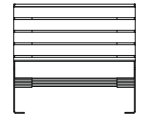
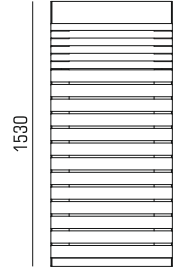
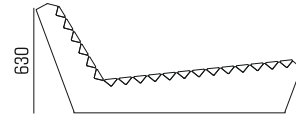
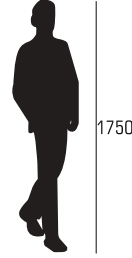
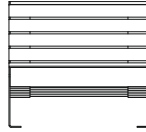

700

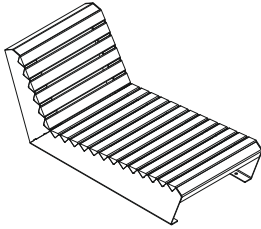

metal / metal

ahşap / wood

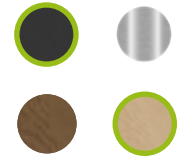



DELTA KARE SAKSI / DELTA SQUARE PLANTER

Sac / Sheet metal

MALZEMELER / MATERIALS

- ST 37 Galvanizli sac, AISI 316 Krom sac
/ ST 37 Galvanized Sheet metal, AISI 316 Chrome Sheet metal
- Accoya, 1. Sınıf Çam / Koyu renkli, Açık renkli ahşap
/ Accoya, 1st Class Pine / Dark wood, Light wood

YÜZEY İŞLEMLERİ / FINISHING

- Astarlama / Primer coating
- Tekstureli Füme boya 7021 / Textured Fume Colour 7021

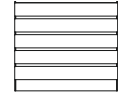
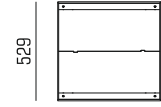
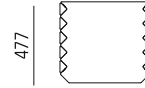
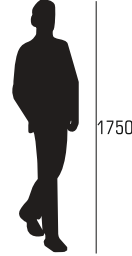
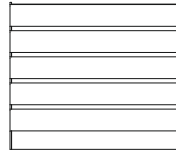

550

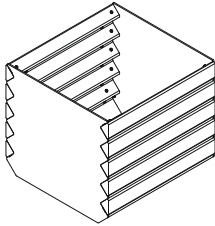

metal / metal

ahşap / wood

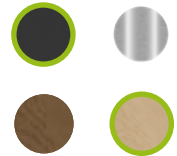

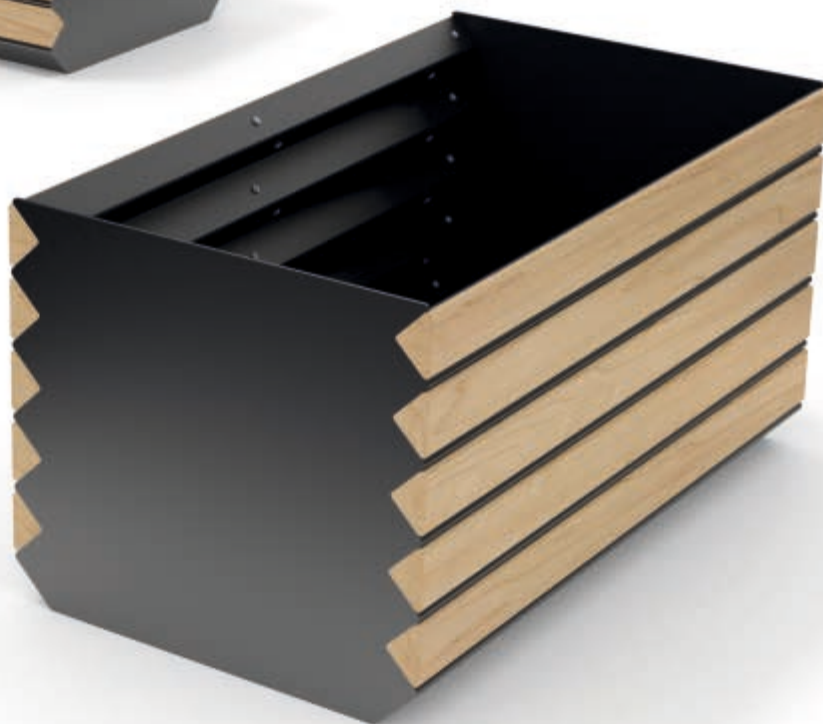

DELTA DİKTÖRTGEN SAKSI / DELTA RECTANGULAR PLANTER

Sac / Sheet metal

MALZEMELER / MATERIALS

- ST 37 Galvanizli sac, AISI 316 Krom sac
/ ST 37 Galvanized Sheet metal, AISI 316 Chrome Sheet metal

- Accoya, 1. Sınıf Çam / Koyu renkli, Açık renkli ahşap
/ Accoya, 1st Class Pine / Dark wood, Light wood

YÜZEY İŞLEMLERİ / FINISHING

Astarlama / Primer coating

Tekstureli Füme boya 7021 / Textured Fume Colour 7021

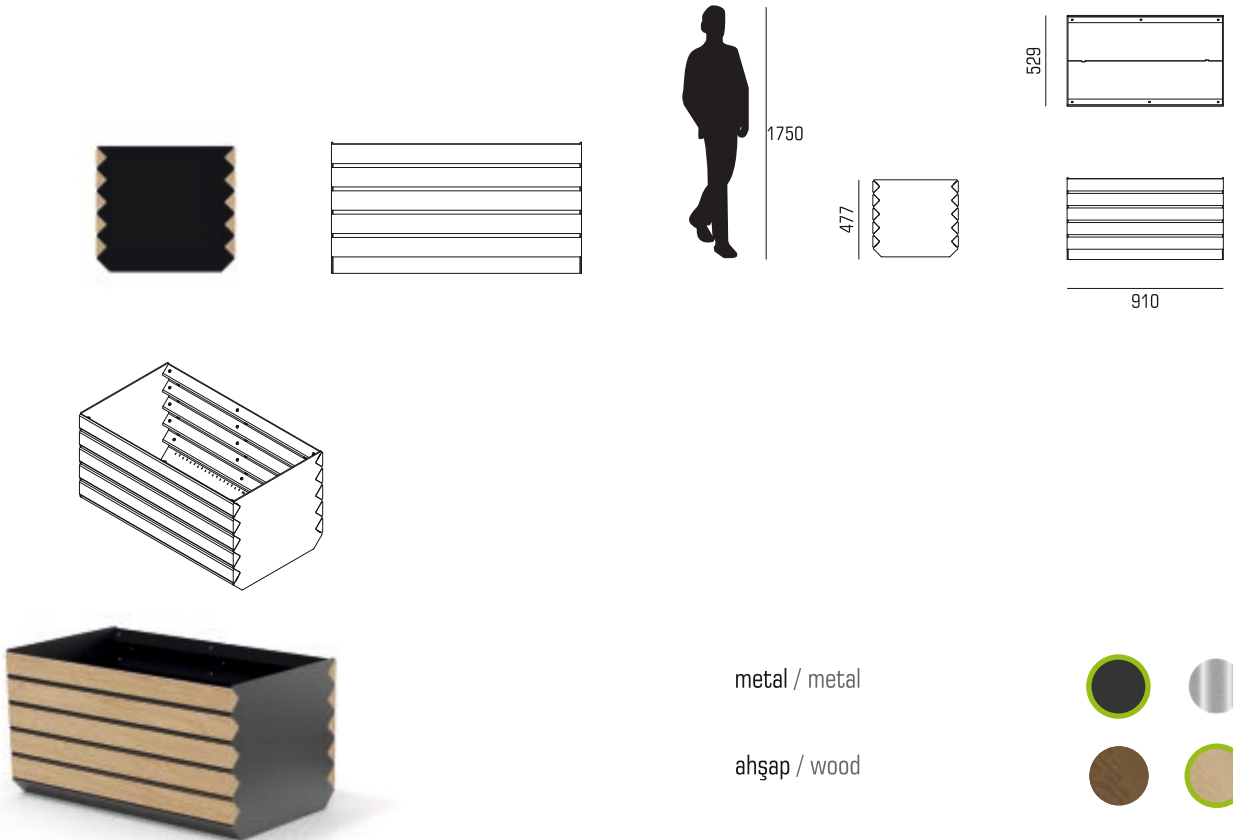

EDGE SERİSİ /EDGE SERIES

Edge serisi, çizgilerinde şehir hayatının dinamik, hızlı ve keskin yanlarını barındırırken aynı zamanda içe dönük sırtlık tasarımı sayesinde şehir yaşantısı içinde birbirinden uzaklaşan insanları yakınlaştırmayı hedeflemiştir. Serinin en kritik noktası bütün ürünlerin tek parça sacın bükülmesiyle ortaya çıkarılabilesidir.

Whereas the Edge series has the dynamic, fast and sharp aspects of urban life on the lines, at the same time, it aims to get the people, who become distant from each other in urban life, close to each other thanks to its inward-oriented backrest design. The most critical point of the series is that all products can be produced by bending a single piece of sheet metal.

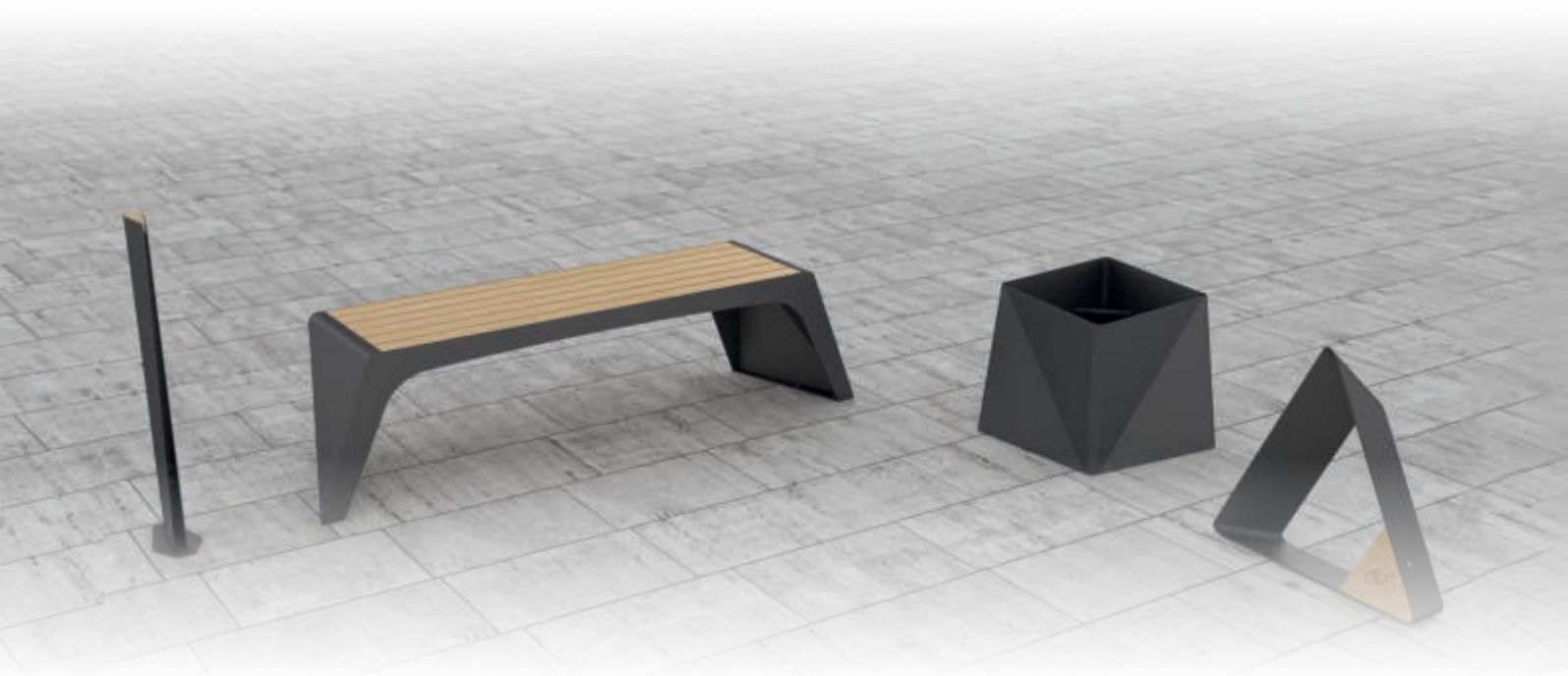



EDGE SAKSI / EDGE PLANTER

Sac / Sheet metal

MALZEMELER / MATERIALS

- ST 37 Galvanizli sac, AISI 316 Krom sac
/ ST 37 Galvanized Sheet metal, AISI 316 Chrome Sheet metal

YÜZEY İŞLEMLERİ / FINISHING

Astarlama / Primer coating
Tekstürel Füme boya 7021 / Textured Fume Colour 7021

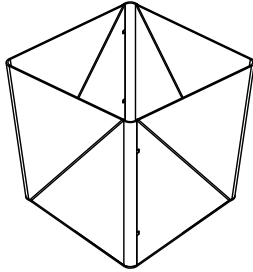
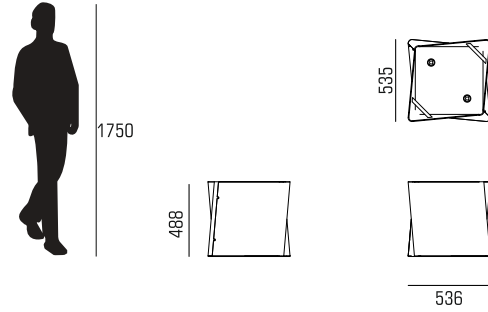
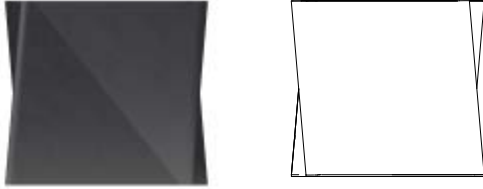

metal / metal





EDGE SIRTLIKSIZ BANK / EDGE STANDARD BENCH

Sac / Sheet metal

MALZEMELER / MATERIALS

- ST 37 Galvanizli sac, AISI 316 Krom sac
/ ST 37 Galvanized Sheet metal, AISI 316 Chrome Sheet metal
- Accoya, 1. Sınıf Çam / Koyu renkli, Açık renkli ahşap
/ Accoya, 1st Class Pine / Dark wood, Light wood

YÜZEY İŞLEMLERİ / FINISHING

- Astarlama / Primer coating
- Tekstureli Füme boya 7021 / Textured Fume Colour 7021

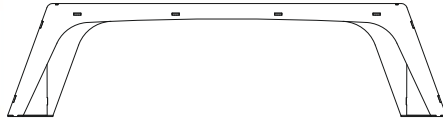

1750

460



471

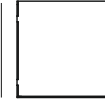

1828

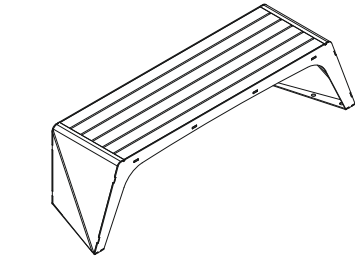

metal / metal

ahşap / wood

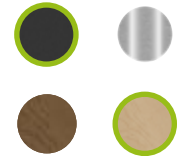

CJS 554



EDGE BİSİKLET PARKI / EDGE BIKE RACK

Sac / Sheet metal

MALZEMELER / MATERIALS

- ST 37 Galvanizli sac, AISI 316 Krom sac
/ ST 37 Galvanized Sheet metal, AISI 316 Chrome Sheet metal
- Accoya, 1. Sınıf Çam / Koyu renkli, Açık renkli ahşap
/ Accoya, 1st Class Pine / Dark wood, Light wood

YÜZEY İŞLEMLERİ / FINISHING

- Astarlama / Primer coating
- Tekstureli Füme boya 7021 / Textured Fume Colour 7021

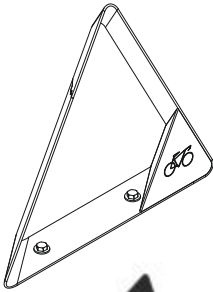
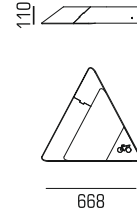
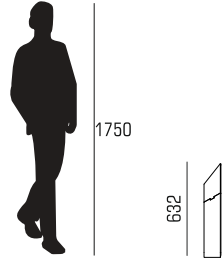
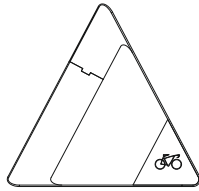

metal / metal

ahşap / wood

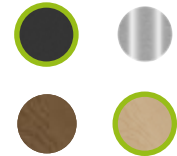



EDGE SINIRLANDIRICI / EDGE BOLLARD

Sac / Sheet metal

MALZEMELER / MATERIALS

- ST 37 Galvanizli sac, AISI 316 Krom sac
/ ST 37 Galvanized Sheet metal, AISI 316 Chrome Sheet metal
- Accoya, 1. Sınıf Çam / Koyu renkli, Açık renkli ahşap
/ Accoya, 1st Class Pine / Dark wood, Light wood

YÜZEY İŞLEMLERİ / FINISHING

- Astarlama / Primer coating
- Tekstureli Füme boya 7021 / Textured Fume Colour 7021

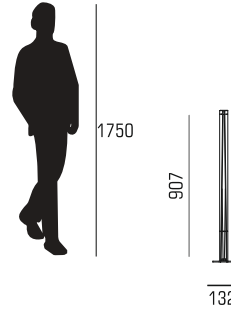

metal / metal

ahşap / wood

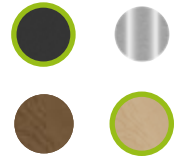

BEND SERİSİ / BEND SERIES

Bend serisi, çizgilerinde şehir hayatının dinamik, hızlı ve keskin yanlarını barındırırken aynı zamanda içe dönük sırtlık tasarımı sayesinde şehir yaşantısı içinde birbirinden uzaklaşan insanları yakınlaştırmayı hedeflemiştir. Serinin en kritik noktası bütün ürünlerin tek parça sacın bükülmesiyle ortaya çıkarılabilmektedir.

Whereas the Edge series has the dynamic, fast and sharp aspects of urban life on the lines, at the same time, it aims to get the people, who become distant from each other in urban life, close to each other thanks to its inward-oriented backrest design. The most critical point of the series is that all products can be produced by bending a single piece of sheet metal.

BEND SERİSİ / BEND SERIES





BEND SIRTЛИKLI BANK / BEND BACKREST BENCH

Sac / Sheet metal

MALZEMELER / MATERIALS

- ST 37 Galvanizli sac, AISI 316 Krom sac
/ ST 37 Galvanized Sheet metal, AISI 316 Chrome Sheet metal
- Accoya, 1. Sınıf Çam / Koyu renkli, Açık renkli ahşap
/ Accoya, 1st Class Pine / Dark wood, Light wood

YÜZEY İŞLEMLERİ / FINISHING

- Astarlama / Primer coating
- Tekstureli Füme boya 7021 / Textured Fume Colour 7021

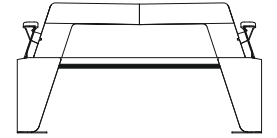
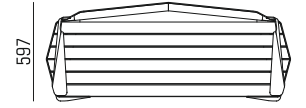
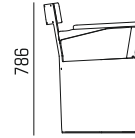
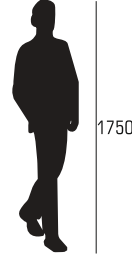
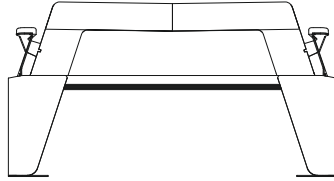

1479

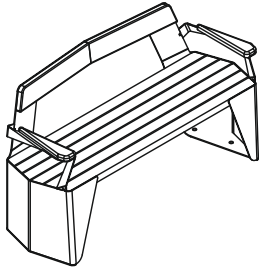

metal / metal

ahşap / wood

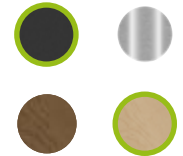



BEND SINIRLANDIRICI / BEND BOLLARD

Sac / Sheet metal

MALZEMELER / MATERIALS

- ST 37 Galvanizli sac, AISI 316 Krom sac
/ ST 37 Galvanized Sheet metal, AISI 316 Chrome Sheet metal
- Accoya, 1. Sınıf Çam / Koyu renkli, Açık renkli ahşap
/ Accoya, 1st Class Pine / Dark wood, Light wood

YÜZEY İŞLEMLERİ / FINISHING

- Astarlama / Primer coating
- Tekstureli Füme boya 7021 / Textured Fume Colour 7021

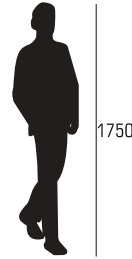

75



179



metal / metal

ahşap / wood

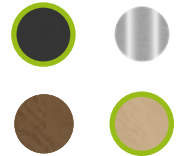

ZEBRA SERİSİ / ZEBRA SERIES

Bu seri için, ürün çizgilerini belirleyen borular üzerine kullanım alanlarını yaratan şerit ahşaplar ile bir form oluşturulmuş ve bu form boyunca devam eden ahşaplar ile oluşturulan algının Zebra ismi ile öne çıkması sağlanmıştır. Zebra serisinde, kullanım alanlarını yaratan ahşaplar forma uygun olarak şekillenirken, serinin formu da ergonomik bir kullanım hedeflenerek tasarlanmıştır. Seri tasarlanırken, kullanılan ahşaplar ve belirlenen açılar ile pazar gereksinimi ve farklı kullanım senaryoları göz önünde tutulmuş, sürekli devam eden kıvrımlı konstrüksiyon ile ürünler hayat bulmuştur.

For this series, a form has been created with strips of wood that creates use areas on the pipes that determine the product lines, and the sense created with the wood that continues throughout this form has been made to stand out with the Zebra name. In the Zebra series, the form of the series has been designed aiming at an ergonomic use while the woods that create use areas are being shaped in accordance with the form. While designing the series, market requirement and different usage scenarios have been considered along with the wood used and angles determined, also the products have come to life with the continuous curved construction.

ZEBRA SERİSİ / ZEBRA SERIES



CUS 151



ZEBRA SIRTЛИKLI BANK / ZEBRA BACKREST BENCH

Boru / Tube

MALZEMELER / MATERIALS

- ST 37 Metal Boru, AISI 316 Krom Boru
/ ST 37 Metal Tube, AISI 316 Chrome Tube
- Accoya, 1. Sınıf Çam / Koyu renkli, Açık renkli ahşap
/ Accoya, 1st Class Pine / Dark wood, Light wood

YÜZEY İŞLEMLERİ / FINISHING

Kumlama / Sandblasted

Koyu Gri Boya Akzo Nobel SW306 G

/ Dark Gray Colour Akzo Nobel Sw306 G

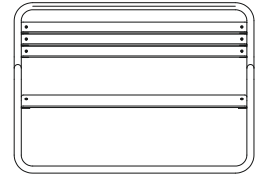
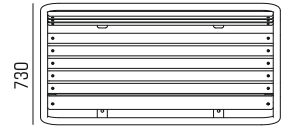
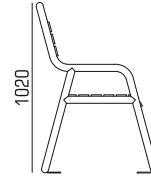
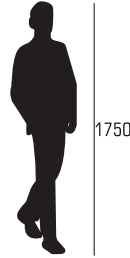
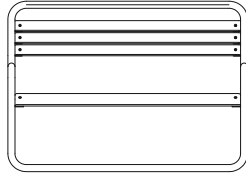

1435

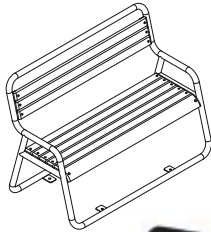

boru / tube

ahşap / wood

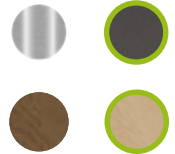



ZEBRA ÇOKLU BANK / ZEBRA MULTIFUNCTION BENCH

Boru / Tube

MALZEMELER / MATERIALS

- ST 37 Metal Boru, AISI 316 Krom Boru
/ ST 37 Metal Tube, AISI 316 Chrome Tube
- Accoya, 1. Sınıf Çam / Koyu renkli, Açık renkli ahşap
/ Accoya, 1st Class Pine / Dark wood, Light wood

YÜZEY İŞLEMLERİ / FINISHING

Kumlama / Sandblasted

Koyu Gri Boya Akzo Nobel SW306 G

/ Dark Gray Colour Akzo Nobel Sw306 G

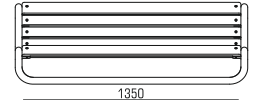
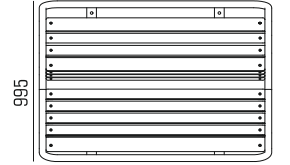
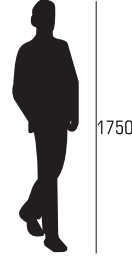
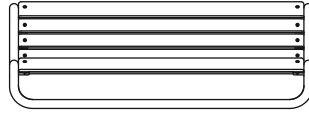

1435

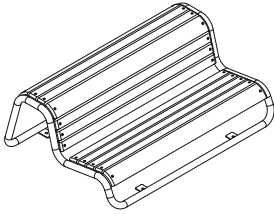

boru / tube

ahşap / wood

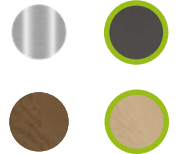



ZEBRA SIRTLIKSIZ BANK / ZEBRA STANDARD BENCH

Boru / Tube

MALZEMELER / MATERIALS

- ST 37 Metal Boru, AISI 316 Krom Boru
/ ST 37 Metal Tube, AISI 316 Chrome Tube
- Accoya, 1. Sınıf Çam / Koyu renkli, Açık renkli ahşap
/ Accoya, 1st Class Pine / Dark wood, Light wood

YÜZEY İŞLEMLERİ / FINISHING

Kumlama / Sandblasted

Koyu Gri Boya Akzo Nobel SW306 G

/ Dark Gray Colour Akzo Nobel Sw306 G

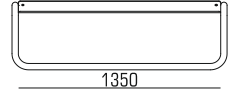
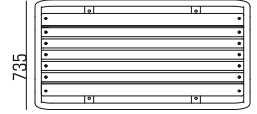
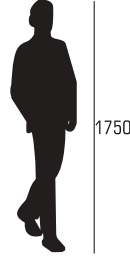
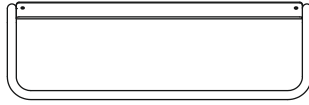

1435

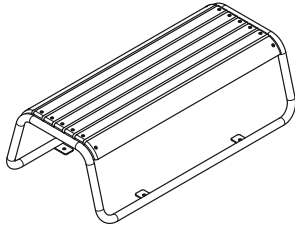

boru / tube

ahşap / wood

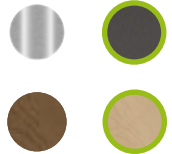



ZEBRA YARI SIRTLIKLI BANK / ZEBRA HALF BACKREST BENCH

Boru / Tube

MALZEMELER / MATERIALS

- ST 37 Metal Boru, AISI 316 Krom Boru
/ ST 37 Metal Tube, AISI 316 Chrome Tube
- Accoya, 1. Sınıf Çam / Koyu renkli, Açık renkli ahşap
/ Accoya, 1st Class Pine / Dark wood, Light wood

YÜZEY İŞLEMLERİ / FINISHING

Kumlama / Sandblasted

Koyu Gri Boya Akzo Nobel SW306 G

/ Dark Gray Colour Akzo Nobel Sw306 G

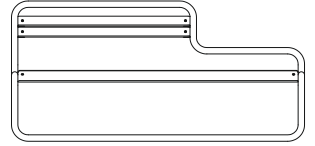
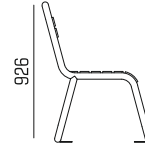
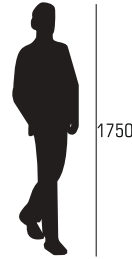
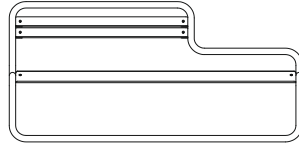

1935

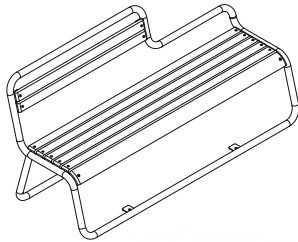

boru / tube

ahşap / wood

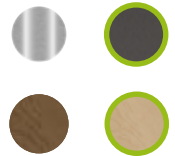

CUS 155



ZEBRA DAYANMA / ZEBRA LEAN

Boru / Tube

MALZEMELER / MATERIALS

- ST 37 Metal Boru, AISI 316 Krom Boru
/ ST 37 Metal Tube, AISI 316 Chrome Tube
- Accoya, 1. Sınıf Çam / Koyu renkli, Açık renkli ahşap
/ Accoya, 1st Class Pine / Dark wood, Light wood

YÜZEY İŞLEMLERİ / FINISHING

Kumlama / Sandblasted

Koyu Gri Boya Akzo Nobel SW306 G

/ Dark Gray Colour Akzo Nobel Sw306 G

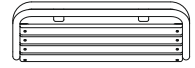
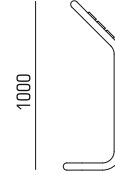
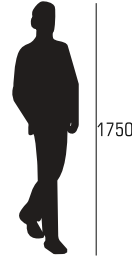
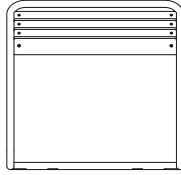

993



1043

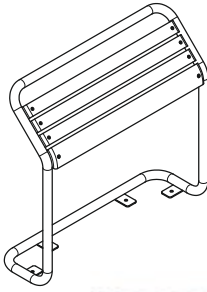

boru / tube

ahşap / wood

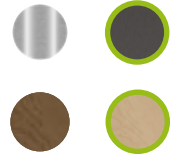



ZEBRA BÜYÜK BİSİKLET PARKI / ZEBRA BIG BIKE RACK

Boru / Tube

MALZEMELER / MATERIALS

- ST 37 Metal Boru, AISI 316 Krom Boru
/ ST 37 Metal Tube, AISI 316 Chrome Tube
- Accoya, 1. Sınıf Çam / Koyu renkli, Açık renkli ahşap
/ Accoya, 1st Class Pine / Dark wood, Light wood

YÜZEY İŞLEMLERİ / FINISHING

Kumlama / Sandblasted

Koyu Gri Boya Akzo Nobel SW306 G

/ Dark Gray Colour Akzo Nobel Sw306 G

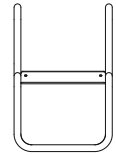
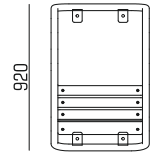
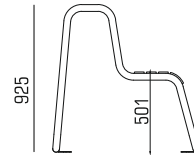
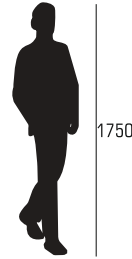
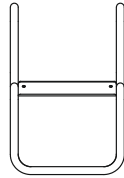

615

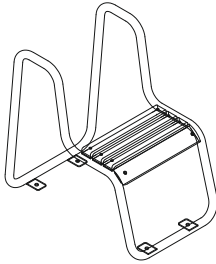

boru / tube

ahşap / wood

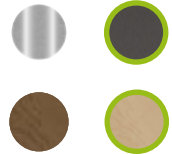



ZEBRA BİSİKLET PARKI / ZEBRA BIKE RACK

Boru / Tube

MALZEMELER / MATERIALS

- ST 37 Metal Boru, AISI 316 Krom Boru
/ ST 37 Metal Tube, AISI 316 Chrome Tube

YÜZEY İŞLEMLERİ / FINISHING

Kumlama / Sandblasted

Koyu Gri Boya Akzo Nobel SW306 G

/ Dark Gray Colour Akzo Nobel SW306 G

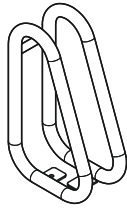
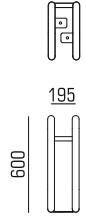
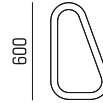
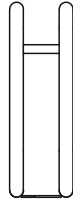

boru / tube





MALZEMELER / MATERIALS

- ST 37 Metal Boru, AISI 316 Krom Boru
/ ST 37 Metal Tube, AISI 316 Chrome Tube
- Accoya, 1. Sınıf Çam / Koyu renkli, Açık renkli ahşap
/ Accoya, 1st Class Pine / Dark wood, Light wood

YÜZEY İŞLEMLERİ / FINISHING

Kumlama / Sandblasted

Koyu Gri Boya Akzo Nobel SW306 G

/ Dark Gray Colour Akzo Nobel Sw306 G

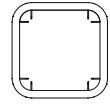
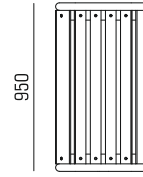
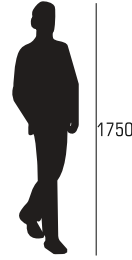
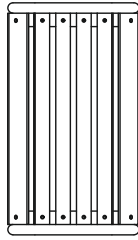
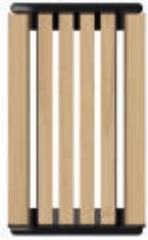

557

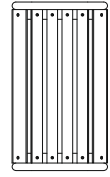

557

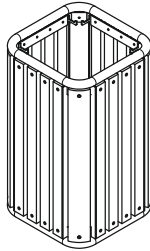

boru / tube

ahşap / wood

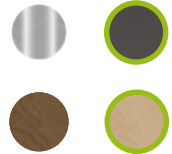



ZEBRA SINIRLANDIRICI / ZEBRA BOLLARD

Boru / Tube

MALZEMELER / MATERIALS

- ST 37 Metal Boru, AISI 316 Krom Boru
/ ST 37 Metal Tube, AISI 316 Chrome Tube

YÜZEY İŞLEMLERİ / FINISHING

Kumlama / Sandblasted

Koyu Gri Boya Akzo Nobel SW306 G

/ Dark Gray Colour Akzo Nobel SW306 G

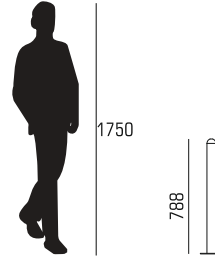

150



60

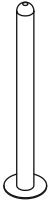

boru / tube



CUS 160



CUS 161



ZEBRA PİKNIK MASASI / ZEBRA PICNIC TABLE

Boru / Tube

MALZEMELER / MATERIALS

- ST 37 Metal Boru, AISI 316 Krom Boru
/ ST 37 Metal Tube, AISI 316 Chrome Tube
- Accoya, 1. Sınıf Çam / Koyu renkli, Açık renkli ahşap
/ Accoya, 1st Class Pine / Dark wood, Light wood

YÜZEY İŞLEMLERİ / FINISHING

Kumlama / Sandblasted

Koyu Gri Boya Akzo Nobel SW306 G

/ Dark Gray Colour Akzo Nobel Sw306 G

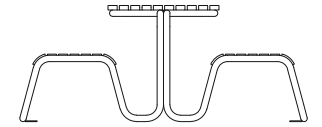
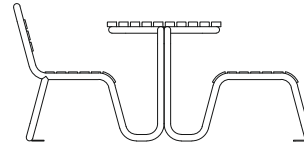
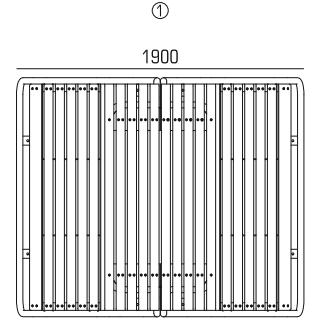
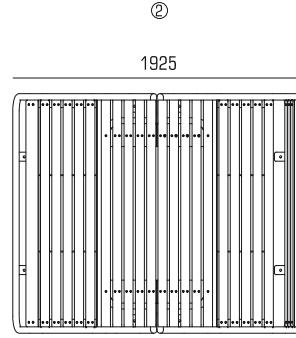
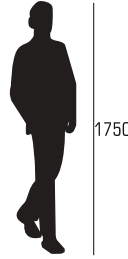

1585

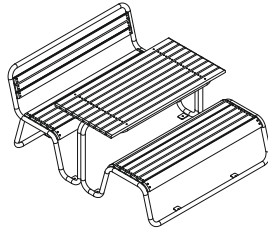
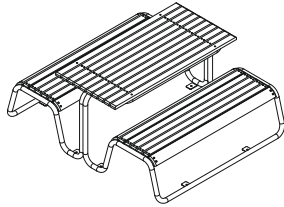

boru / tube

ahşap / wood

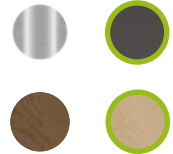



ZEBRA KARE SAKSI / ZEBRA SQUARE PLANTER

Boru / Tube

MALZEMELER / MATERIALS

- ST 37 Metal Boru, AISI 316 Krom Boru
/ ST 37 Metal Tube, AISI 316 Chrome Tube
- Accoya, 1. Sınıf Çam / Koyu renkli, Açık renkli ahşap
/ Accoya, 1st Class Pine / Dark wood, Light wood

YÜZEY İŞLEMLERİ / FINISHING

Kumlama / Sandblasted

Koyu Gri Boya Akzo Nobel SW306 G

/ Dark Gray Colour Akzo Nobel Sw306 G

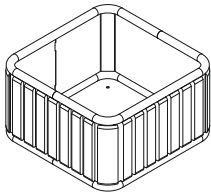
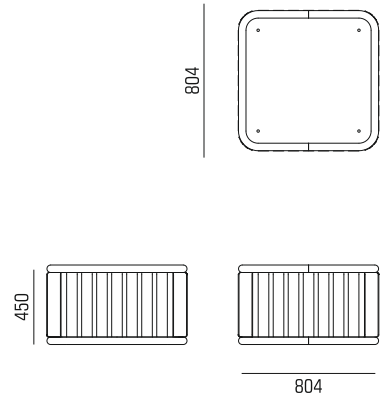
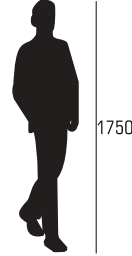
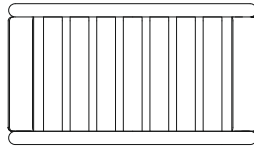

boru / tube

ahşap / wood

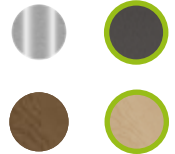



ZEBRA DİKTÖRTGEN SAKSI / ZEBRA RECTANGLE PLANTER

Boru / Tube

MALZEMELER / MATERIALS

- ST 37 Metal Boru, AISI 316 Krom Boru
/ ST 37 Metal Tube, AISI 316 Chrome Tube
- Accoya, 1. Sınıf Çam / Koyu renkli, Açık renkli ahşap
/ Accoya, 1st Class Pine / Dark wood, Light wood

YÜZEY İŞLEMLERİ / FINISHING

Kumlama / Sandblasted

Koyu Gri Boya Akzo Nobel SW306 G

/ Dark Gray Colour Akzo Nobel Sw306 G

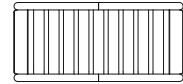
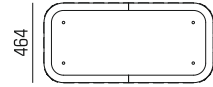
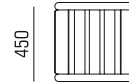
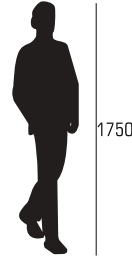
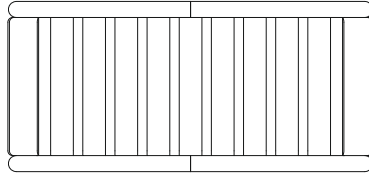

974

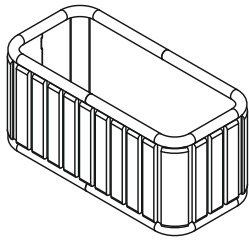

boru / tube

ahşap / wood

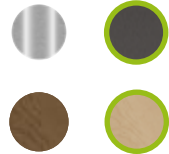



ZEBRA AĞAÇ SAKSI / ZEBRA TREE PLANTER

Boru / Tube

MALZEMELER / MATERIALS

- ST 37 Metal Boru, AISI 316 Krom Boru
/ ST 37 Metal Tube, AISI 316 Chrome Tube
- Accoya, 1. Sınıf Çam / Koyu renkli, Açık renkli ahşap
/ Accoya, 1st Class Pine / Dark wood, Light wood

YÜZEY İŞLEMLERİ / FINISHING

Kumlama / Sandblasted

Koyu Gri Boya Akzo Nobel SW306 G

/ Dark Gray Colour Akzo Nobel Sw306 G

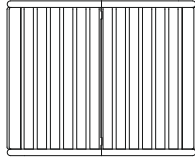
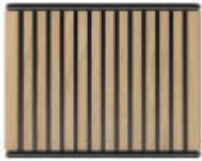

1750

960

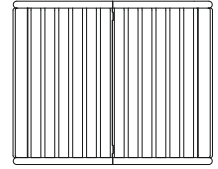
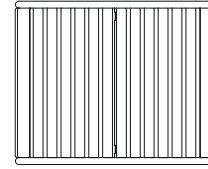

1228

1228

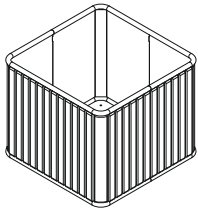
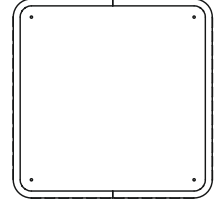

boru / tube

ahşap / wood

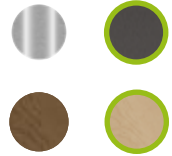

PIET SERİSİ / PIET SERIES

Piet serisi yalnızca sac ve boru kullanımı ile ürün yaratma amacıyla ortaya çıkarılan bir kent ekipmanları serisidir. Borular ürünlerin tamamında merkez kısmı oluştururken dış iskelet saclar ile kapatılmış ve borular ile sac parçaların birbirini desteklemesi sağlanmıştır. Böylece boşluklu bir yapı oluşturulmuş ve ürünlerin dinamik çizgilere sahip olması sağlanmıştır. Borular yerleştirilirken özellikle mesafeli şekilde konumlandırılmış böylece kapalı kutu algısını kıran daha ferah bir yapı oluşturulmuştur.

Piet series is a series of urban equipments which is developed for the purpose of creating products by using only sheet metal and pipe. While the pipes form the central part of all products, the external framework is covered with sheet metal and the pipe and sheet metal parts support to each other. By this way a space structure is created and the products have dynamic lines. Especially the pipes are positioned as distanced, so a wider structure breaking the closed box sense is formed.

PIET SERİSİ / PIET SERIES





PIET SIRTЛИKLI BANK / PIET BACKREST BENCH

Boru / Tube

MALZEMELER / MATERIALS

- ST 37 Boru ve sac , AISI Krom boru ve sac
/ ST 37 Tube and Sheet Metal, AISI Chrome Tube and Sheet Metal

YÜZEY İŞLEMLERİ / FINISHING

Astarlama / Primer coating

Mavi boya 5024 / Pastel Blue 5024

Gri boya 7026 / Granite Grey 7026

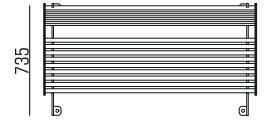
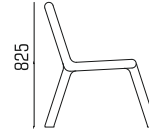
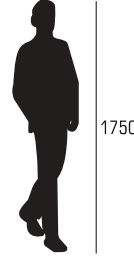

1410

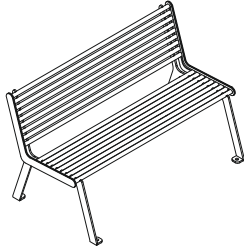

boru / tube

metal / metal

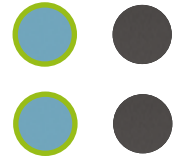



PIET SIRTLIKSIZ BANK / PIET STANDARD BENCH

Boru / Tube

MALZEMELER / MATERIALS

- ST 37 Boru ve sac , AISI Krom boru ve sac
/ ST 37 Tube and Sheet Metal, AISI Chrome Tube and Sheet Metal

YÜZEY İŞLEMLERİ / FINISHING

Astarlama / Primer coating

Mavi boya 5024 / Pastel Blue 5024

Gri boya 7026 / Granite Grey 7026

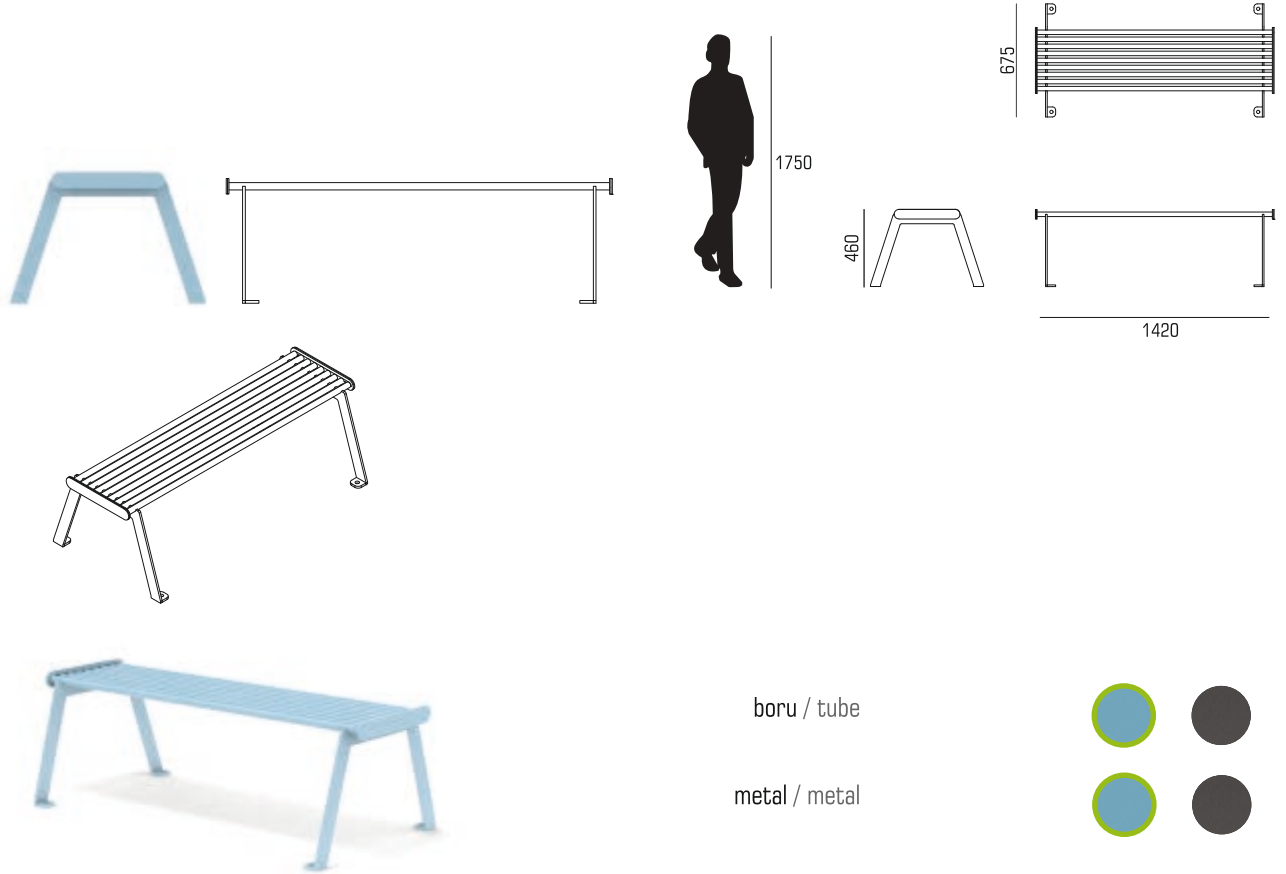



PIET BİSİKLET PARKI / PIET BIKE RACK

Boru / Tube

MALZEMELER / MATERIALS

- ST 37 Boru ve sac , AISI Krom boru ve sac
/ ST 37 Tube and Sheet Metal, AISI Chrome Tube and Sheet Metal

YÜZEY İŞLEMLERİ / FINISHING

Astarlama / Primer coating

Mavi boya 5024 / Pastel Blue 5024

Gri boya 7026 / Granite Grey 7026

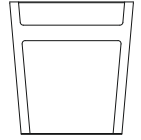
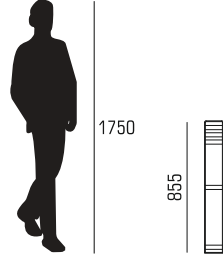
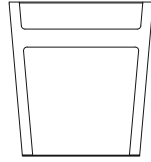

800

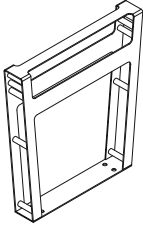

boru / tube

metal / metal

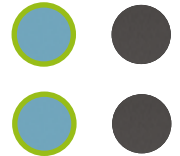

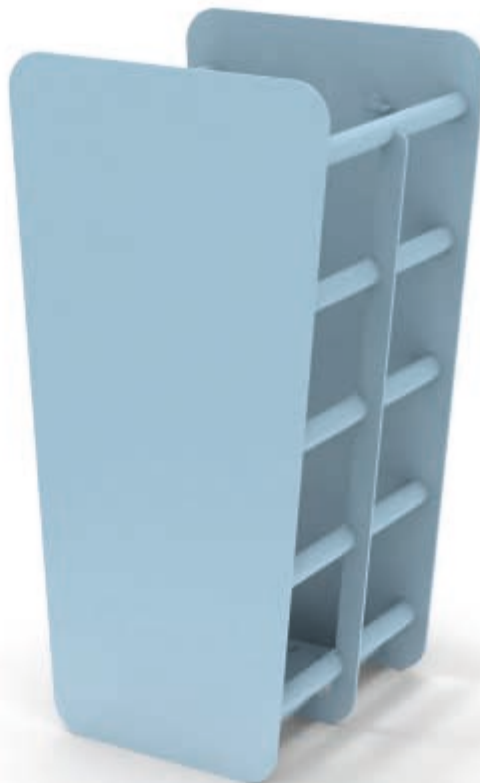
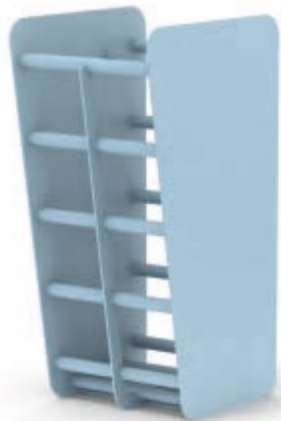

MALZEMELER / MATERIALS

- ST 37 Boru ve sac , AISI Krom boru ve sac
/ ST 37 Tube and Sheet Metal, AISI Chrome Tube and Sheet Metal

YÜZEY İŞLEMLERİ / FINISHING

Astarlama / Primer coating
Mavi boya 5024 / Pastel Blue 5024
Gri boya 7026 / Granite Grey 7026

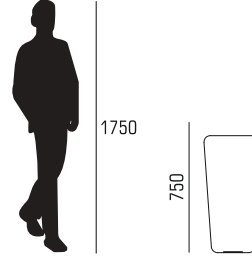

350

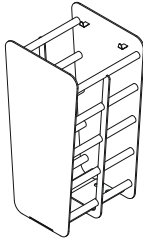

boru / tube

metal / metal

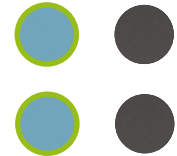

71SERİSİ / 71 SERIE

71 serisi, piyasada tespit edilen eksiklik doğrultusunda, marinalarda kullanılmak üzere tasarlanan bir kent mobilyası grubu olarak başladı hayatına. Tasarım çizgisine, yatların dinamik ve modern çizgileri ilham kaynağı oldular ve ürüne hayat verdiler. Böylece; minimal, modern çizgi ve yüzeylere sahip, piyasada farklılık yaratan bir ürün grubu gerçeğe buluştu.

71 serie has commenced as a city furniture group, which is designed to be used in marinas, in accordance with the deficiency of identified in the market. They have provided the inspiration for the design line, the dynamic and modern lines of the yachts and gave life to the product. Thus, a product group which has minimal, modern lines and surfaces and that makes a difference in the market, has become acquainted with the reality.

71 SERİSİ / 71 SERIES





71 SIRTЛИKLI BANK / 71 BACKREST BENCH

alüminyum döküm / cast aluminium

MALZEMELER / MATERIALS

- Alüminyum döküm / Cast aluminium
- Accoya, 1. Sınıf Çam / Koyu renkli, Açık renkli ahşap / Accoya, 1st Class Pine / Dark wood, Light wood

YÜZEY İŞLEMLERİ / FINISHING

Kumlama / Sandblasted

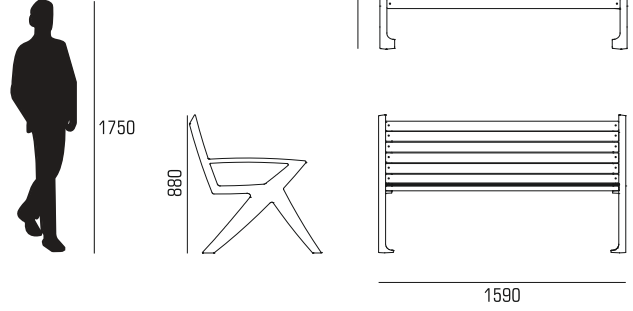
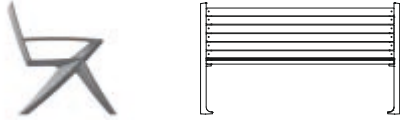

alüminyum / aluminium

ahşap / wood

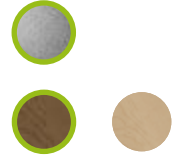



71 BİSİKLET PARKI / 71 BIKE RACK

alüminyum döküm / cast aluminium

MALZEMELER / MATERIALS

- Alüminyum döküm / Cast aluminium

YÜZEY İŞLEMLERİ / FINISHING

Kumlama / Sandblasted

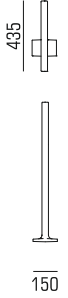
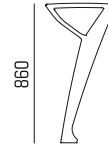
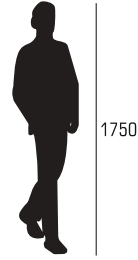

alüminyum / aluminium



CUS 253



71 SINIRLANDIRICI / 71 BOLLARD

alüminyum döküm / cast aluminium

MALZEMELER / MATERIALS

- Alüminyum döküm / Cast aluminium

YÜZEY İŞLEMLERİ / FINISHING

Kumlama / Sandblasted

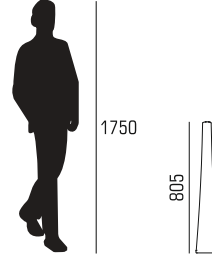
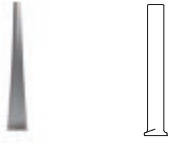

135



100



alüminyum / aluminium



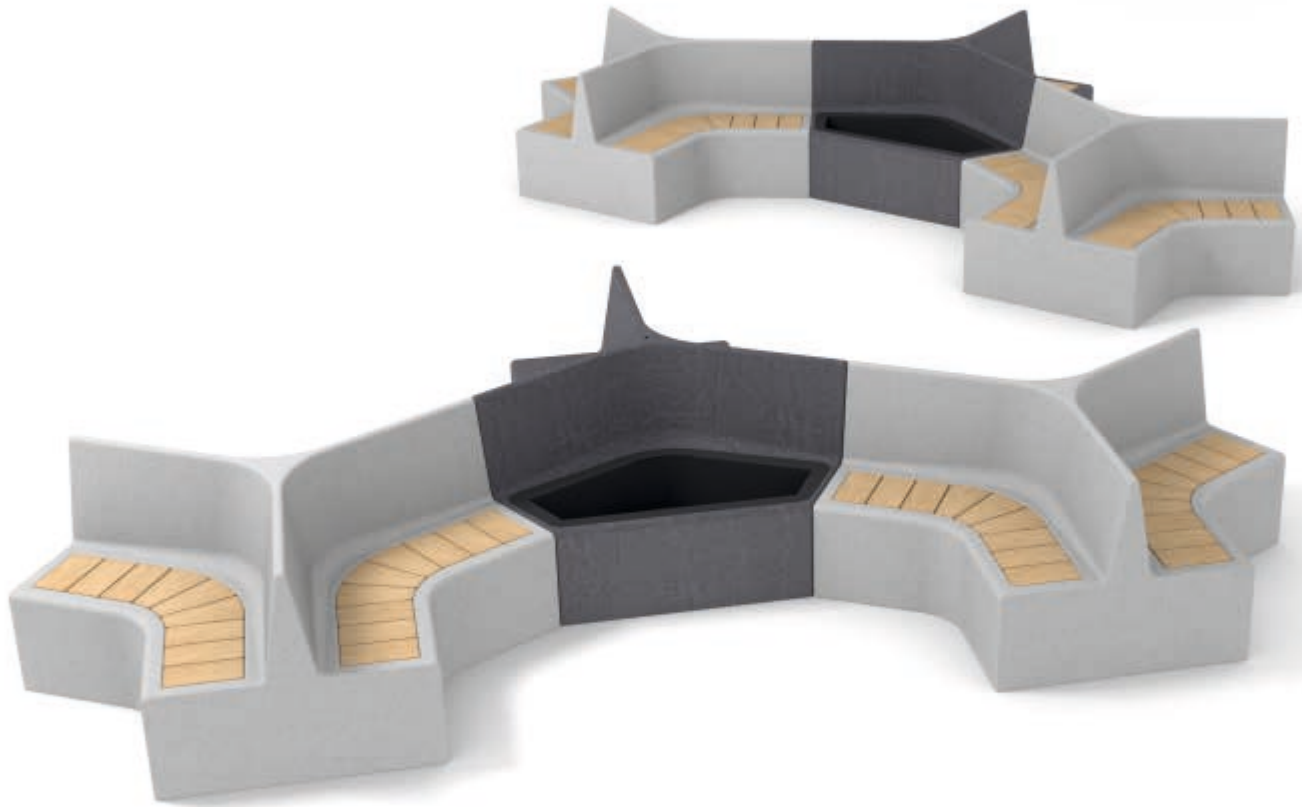

BUMERANG SERİSİ / BUMERANG SERIES

beton / concrete

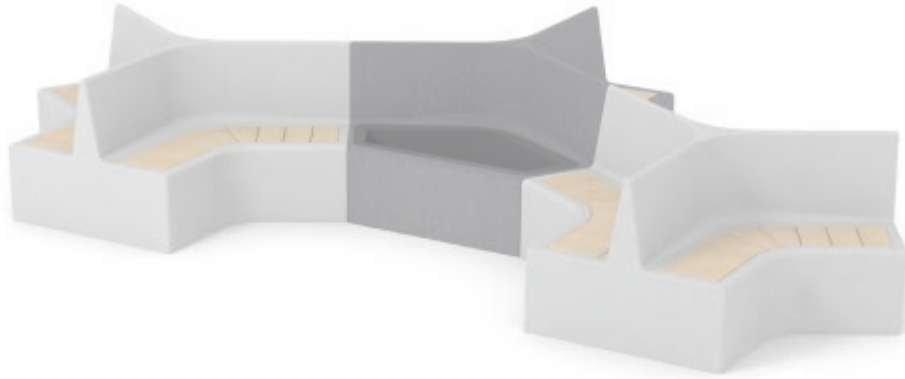

Bumerang, 2 farklı modül olarak düşünülmüş birbirini takip eden tasarım çizgisine sahip beton kent ekipmanı serisidir. Bumerang serisinde; kullanıcıların, ortak bir alanda buluşmalarını sağlayan ve gruplara sosyalleşme alanı yaratan bir ürün ailesi oluşturmayı hedefledik. Ön gördüğümüz üç modül isteğe ve koşullara bağlı olarak sayıca çoğaltılabilir. Bu sayede yaratılmak istenen alana uygun olarak farklı kombinasyonlarda kullanılabilir.

Bumerang series are the concrete urban equipment that made up with two different modules (multipliable) that formed consecutively. In this series, we aimed to design a product group that offers users the opportunity to meet and socialize in the communal areas. Different combinations are available depending on the number of modules.

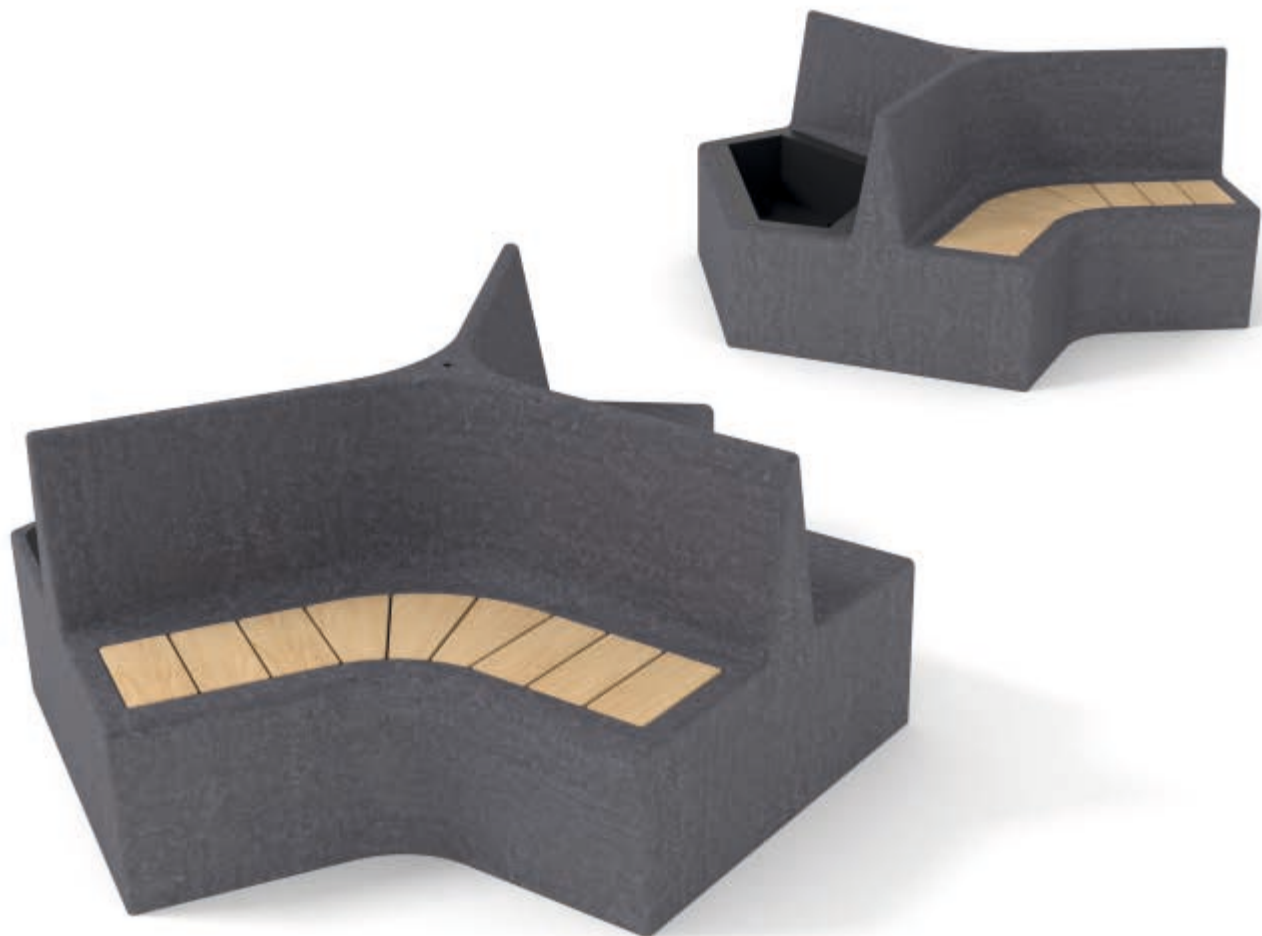

BUMERANG SAKSI BANK / BUMERANG PLANTER BENCH

beton / concrete

MALZEMELER / MATERIALS

- Açık Gri Prekast Beton, Koyu Gri Prekast Beton
/ Precast grey concrete, Precast Dark grey concrete
- ST 37 Galvanizli sac
/ ST 37 Galvanized Sheet metal
- Accoya, 1. Sınıf Çam / Koyu renkli, Açık renkli ahşap
/ Accoya, 1st Class Pine / Dark wood, Light wood

YÜZEY İŞLEMLERİ / FINISHING

Zımparalama / Fine sanding



1750

900

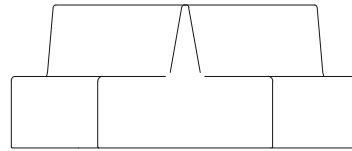

2175

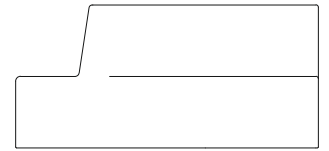
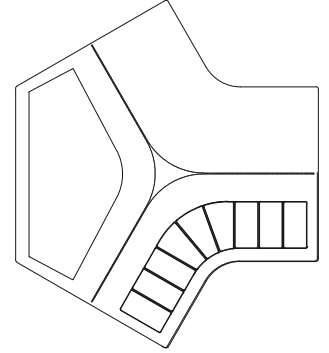

1900

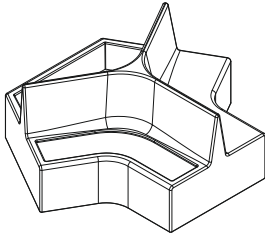

metal / metal

beton / concrete

ahşap / wood



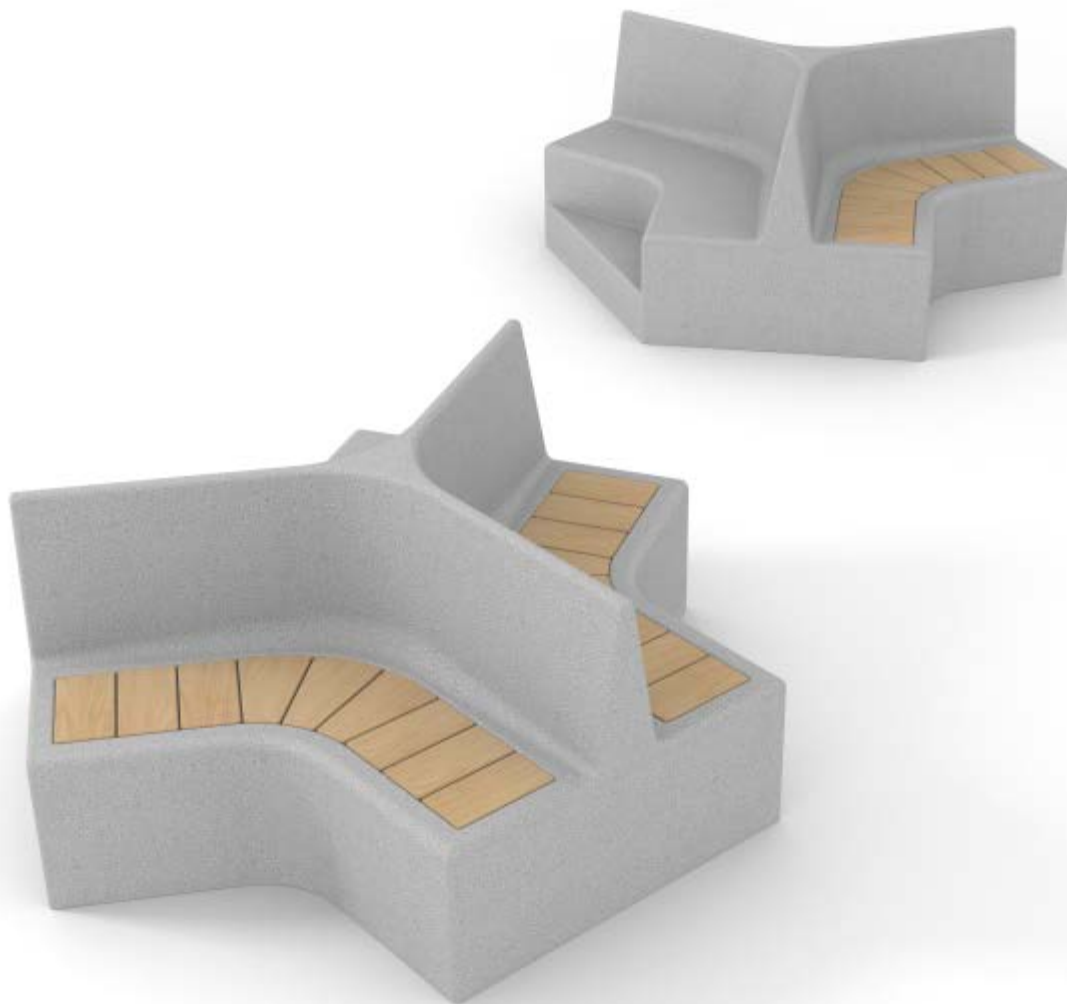

BUMERANG ÇOKLU BANK / BUMERANG MULTIBENCH

beton / concrete

MALZEMELER / MATERIALS

- Açık Gri Prekast Beton, Koyu Gri Prekast Beton
/ Precast grey concrete, Precast Dark grey concrete
- Accoya, 1. Sınıf Çam / Koyu renkli, Açık renkli ahşap
/ Accoya, 1st Class Pine / Dark wood, Light wood

YÜZEY İŞLEMLERİ / FINISHING

Zımparalama / Fine sanding



1750

900

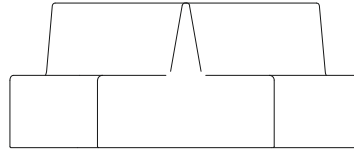

2175

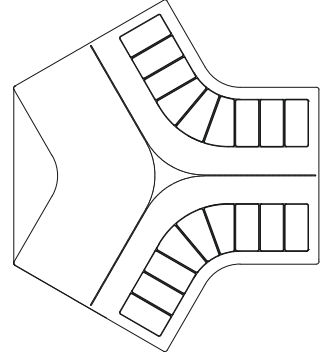

1900

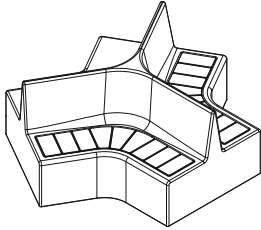

beton / concrete

ahşap / wood

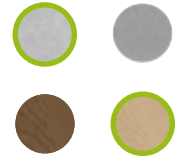

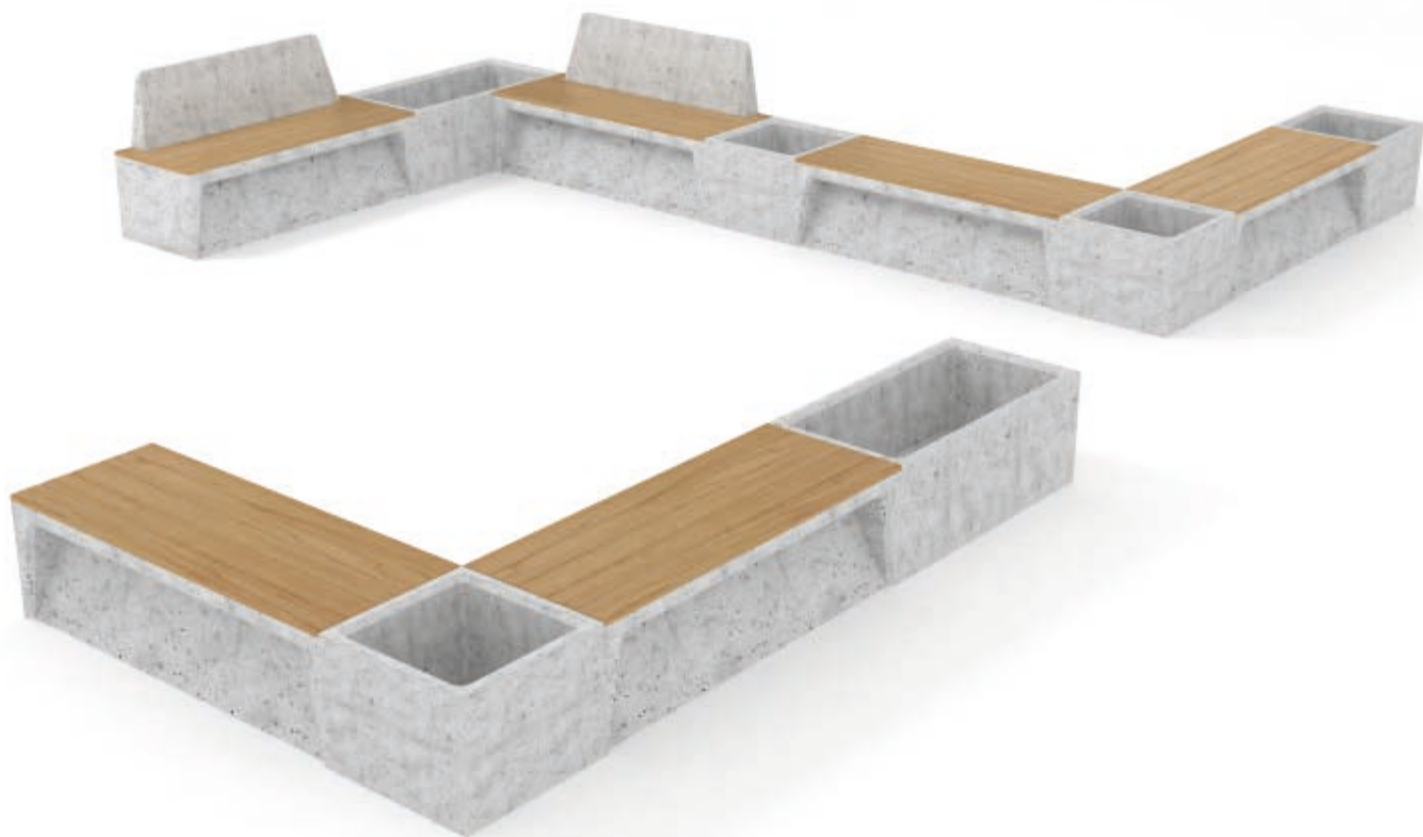

MODÜLER SERİSİ / MODULAR SERIES

beton / concrete



Modüler serisi; anlamına uygun olarak, birbirlerine eklenebilen ürünlerden oluşan kent ekipmanları serisidir. Minimal çizgileri taşıyan bu tasarımıımızdaki ana hedef toplu kullanım alanları yaratmak ve kübik formları işlevselleştirip oluşan boşlukları değerlendirmektir. İstenilen alanda peyzaja uygun olarak, ihtiyaca yönelik farklı kombinasyonlara imkan kılan böylelikle çeşitlilik sağlayan bir ürün grubudur.

Modular series , in conformity with its meaning, are the urban equipments that can be combined with each other. Main purpose of this design work is to create communal areas with the functionalization of cubic forms to use the resultant gaps. Modular series give the opportunity to make different combinations in accordance with the landscape of workspace and the need of usage.



MODÜLER SIRTЛИKLI BANK / MODULAR BACKREST BENCH

beton / concrete

MALZEMELER / MATERIALS

- Açık Gri Prekast Beton, Koyu Gri Prekast Beton
/ Precast grey concrete, Precast Dark grey concrete
- Accoya, 1. Sınıf Çam / Koyu renkli, Açık renkli ahşap
/ Accoya, 1st Class Pine / Dark wood, Light wood

YÜZEY İŞLEMLERİ / FINISHING

- Zımparalama / Epoksi
/ Fine sanding / Epoxy

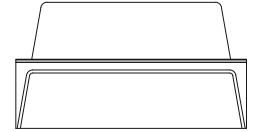
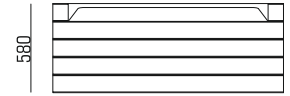
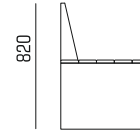
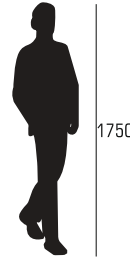
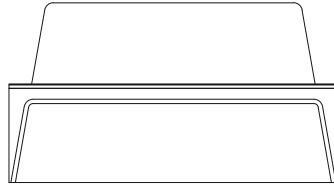

1500

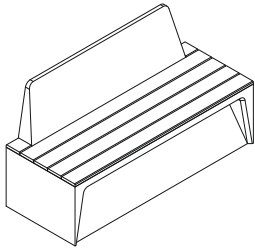

beton / concrete

ahşap / wood

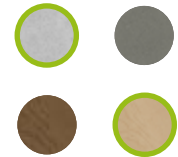



MODÜLER SIRTLIKSIZ BANK / MODULAR STANDARD BENCH

beton / concrete

MALZEMELER / MATERIALS

- Açık Gri Prekast Beton, Koyu Gri Prekast Beton
/ Precast grey concrete, Precast Dark grey concrete
- Accoya, 1. Sınıf Çam / Koyu renkli, Açık renkli ahşap
/ Accoya, 1st Class Pine / Dark wood, Light wood

YÜZEY İŞLEMLERİ / FINISHING

- Zımparalama / Epoksi
/ Fine sanding / Epoxy

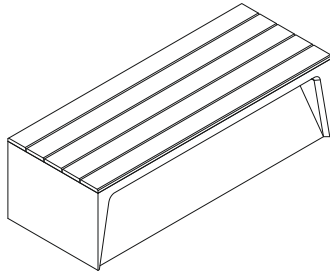
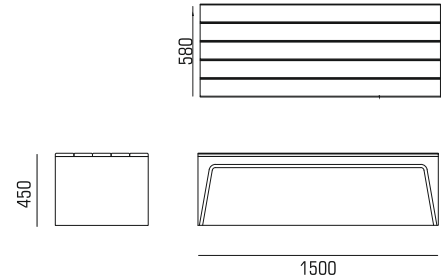
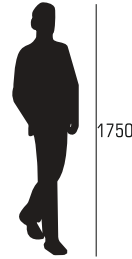
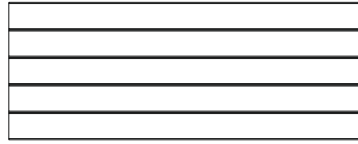

beton / concrete

ahşap / wood

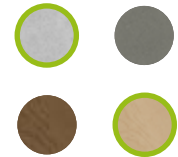



MODÜLER UZUN SAKSI / MODULAR LONG PLANTER

beton / concrete

MALZEMELER / MATERIALS

- Açık Gri Prekast Beton, Koyu Gri Prekast Beton
/ Precast grey concrete, Precast Dark grey concrete

YÜZEY İŞLEMLERİ / FINISHING

- Zımparalama / Epoksi
/ Fine sanding / Epoxy

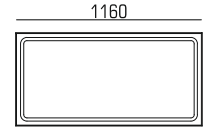
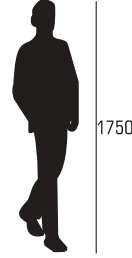

1160

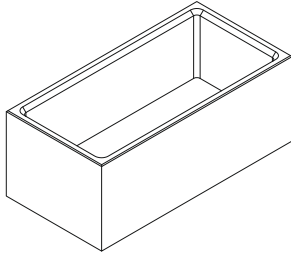

beton / concrete



CUS 354



MODÜLER SAKSI / MODULAR PLANTER

beton / concrete

MALZEMELER / MATERIALS

- Açık Gri Prekast Beton, Koyu Gri Prekast Beton
/ Precast grey concrete, Precast Dark grey concrete

YÜZEY İŞLEMLERİ / FINISHING

- Zımparalama / Epoksi
/ Fine sanding / Epoxy

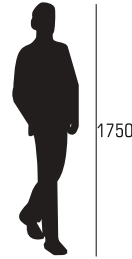

450



580

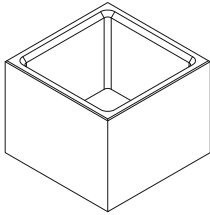

beton / concrete



9040 SERİSİ / 9040 SERIES

9040 serisi betonun alışlagelmiş hantal ve ağır hissettiren algısını kırmaya yönelik yola çıkmış bir bank tasarımıdır. Bu bankın en belirgin özelliği, normalde kesitleri çoğunlukla kalın kullanılan beton malzemeden ince kesitler elde ederek, betonun olağan algısının aksine daha narin daha hafif ve modern çizgiler taşıyor olmasıdır. Ürün 9040 ismini 90mm'den başlayarak 40mm'ye kadar inen kesitlerinden almıştır.

9040 series is a bench design created to break the usual rude and heavy appearance of concrete. The most significant feature of this bench is that it has softer, lighter and modern lines contrary to common concrete thanks to getting thin profiles from the concrete material, which is usually used thick. The product has received its name 9040 from the profiles starting from 90mm down to 40mm.

9040 SERİSİ / 9040 SERIES



CUS 401



9040 SIRTЛИKLI BANK / 9040 BACKREST BENCH

beton / concrete

MALZEMELER / MATERIALS

- Açık Gri Prekast Beton, Koyu Gri Prekast Beton
/ Precast grey concrete, Precast Dark grey concrete
- ST 37 Galvanizli sac
/ ST 37 Galvanized Sheet metal
- Accoya, 1. Sınıf Çam / Koyu renkli, Açık renkli ahşap
/ Accoya, 1st Class Pine / Dark wood, Light wood

YÜZEY İŞLEMLERİ / FINISHING

- Zımparalama / Epoksi
/ Fine sanding / Epoxy

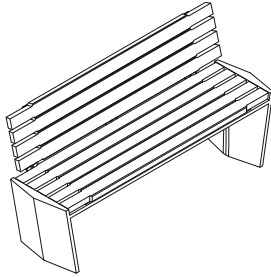
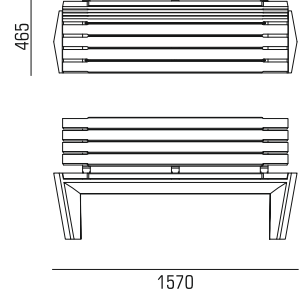
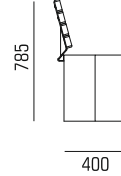
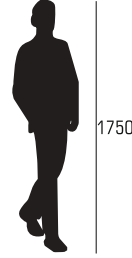
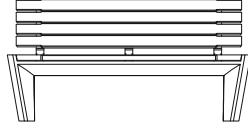

metal / metal

beton / concrete

ahşap / wood





9040 SIRTILISIZ BANK / 9040 STANDARD BENCH

beton / concrete

MALZEMELER / MATERIALS

- Açık Gri Prekast Beton, Koyu Gri Prekast Beton
/ Precast grey concrete, Precast Dark grey concrete
- Accoya, 1. Sınıf Çam / Koyu renkli, Açık renkli ahşap
/ Accoya, 1st Class Pine / Dark wood, Light wood

YÜZEY İŞLEMLERİ / FINISHING

- Zımparalama / Epoksi
/ Fine sanding / Epoxy

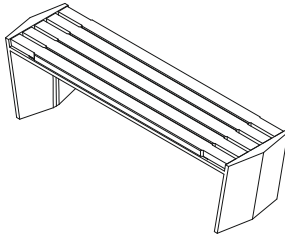
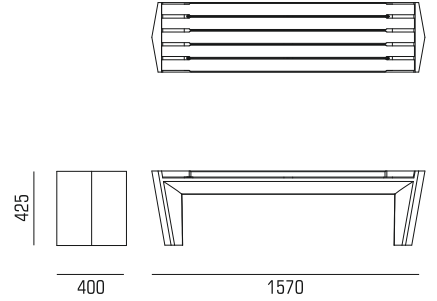
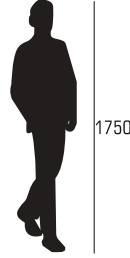

beton / concrete

ahşap / wood

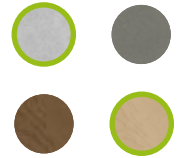

ATLAS SERİSİ / ATLAS SERIES

Atlas, fonksiyonel amorf yüzeylerden oluşan ve 2 farklı tarzda beton kullanımı ile doğanın kesit görüntüsünü ürün ailesine taşıyan bir seridir. Atlas serisinde; amorf yüzeyler, malzeme olarak seçilen betonun algısını değiştiren ergonomik yüzeyler olarak kullanılmıştır. Yapısal bütünlük göz önünde bulundurulduğunda, ürün ailesinin dil birliği için, kesit görüntüsü tasarım çizgisi olarak belirlenmiş ve Atlas serisinin tüm ürünlerine taşınan bu tasarım çizgisi, kimi ürünlerde işlevsellik yerine minimallik ön planda tutularak kullanılmıştır.

Atlas is a series that consists of functional amorphous surfaces and carries the cross-sectional view of the nature to the product family with the use of concrete in two different styles. In Atlas series, amorphous surfaces have been used as ergonomic surfaces that change the perception of concrete selected as material. Considering the structural integrity, the cross-sectional view of the product family has been determined as the design line for the unity of the language, and this design line, which is carried to all products of the Atlas series, is used by prioritizing the minimality in some products instead of functionality.

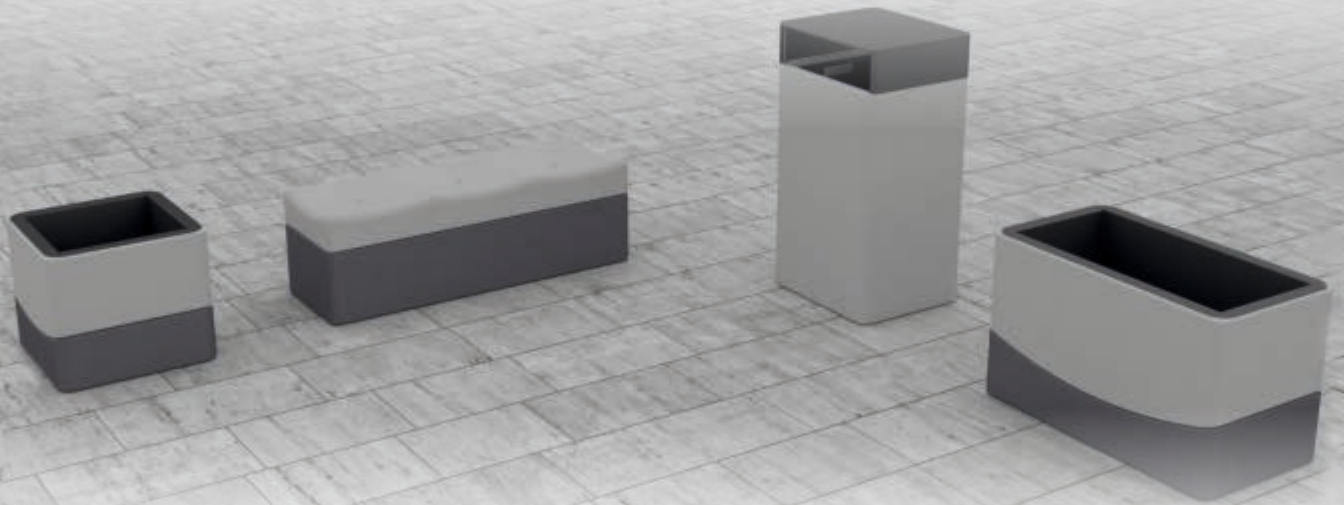

CUS 451



ATLAS SIRTLIKSIZ BANK / ATLAS BENCH

beton / concrete

MALZEMELER / MATERIALS

- Açık Gri Prekast Beton, Koyu Gri Prekast Beton
/ Precast grey concrete, Precast Dark grey concrete

YÜZEY İŞLEMLERİ / FINISHING

- Zımparalama / Fine sanding

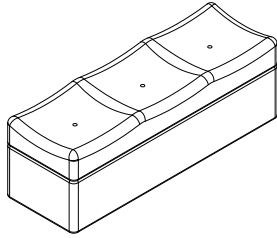
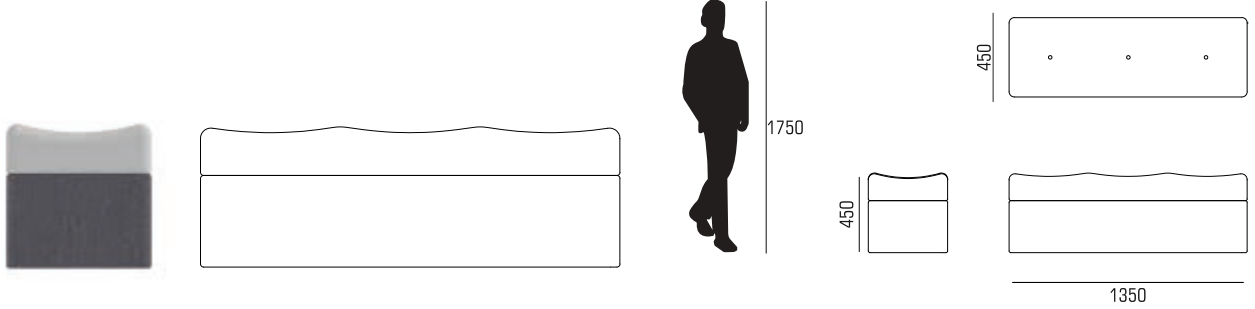

beton / concrete

beton / concrete



CUS 452



ATLAS BÜYÜK SAKSI / ATLAS BIG PLANTER

beton / concrete

MALZEMELER / MATERIALS

- Açık Gri Prekast Beton, Koyu Gri Prekast Beton
/ Precast grey concrete, Precast Dark grey concrete
- ST 37 Galvanizli sac
/ ST 37 Galvanized Sheet metal

YÜZEY İŞLEMLERİ / FINISHING

- Zımparalama / Fine sanding

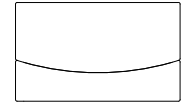
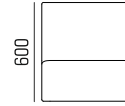
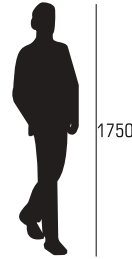
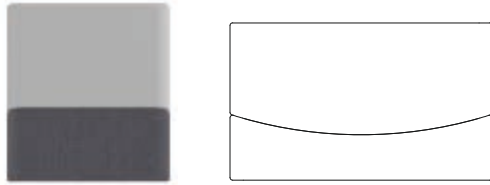

1000

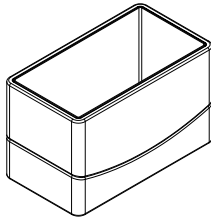

metal / metal

beton / concrete

beton / concrete





ATLAS KÜÇÜK SAKSI / ATLAS SMALL PLANTER

beton / concrete

MALZEMELER / MATERIALS

- Açık Gri Prekast Beton, Koyu Gri Prekast Beton
/ Precast grey concrete, Precast Dark grey concrete

- ST 37 Galvanizli sac
/ ST 37 Galvanized Sheet metal

YÜZEY İŞLEMLERİ / FINISHING

- Zımparalama / Fine sanding

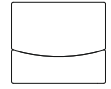
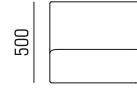
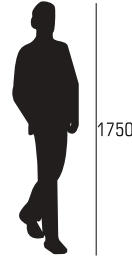
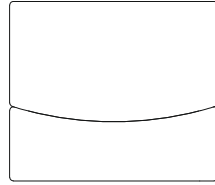

580

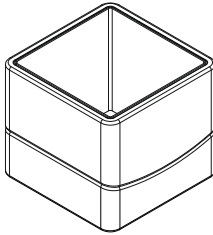

metal / metal

beton / concrete

beton / concrete





MALZEMELER / MATERIALS

- Açık Gri Prekast Beton, Koyu Gri Prekast Beton
/ Precast grey concrete, Precast Dark grey concrete
- ST 37 Galvanizli sac
/ ST 37 Galvanized Sheet metal

YÜZEY İŞLEMLERİ / FINISHING

- Zımparalama / Fine sanding

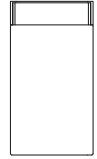
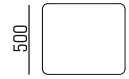
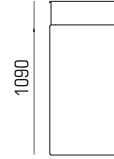
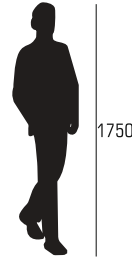

585

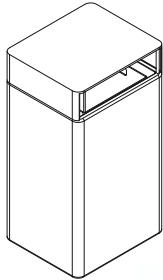

metal / metal

beton / concrete



CUS 455



CUS 457



ATLAS SINIRLANDIRICI / ATLAS BOLLARD

beton / concrete

MALZEMELER / MATERIALS

- Açık Gri Prekast Beton, Koyu Gri Prekast Beton
/ Precast grey concrete, Precast Dark grey concrete
- ST 37 Galvanizli sac
/ ST 37 Galvanized Sheet metal

YÜZEY İŞLEMLERİ / FINISHING

- Zımparalama / Fine sanding

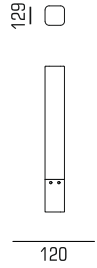
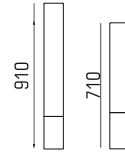
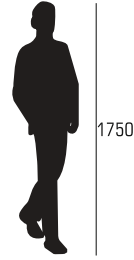
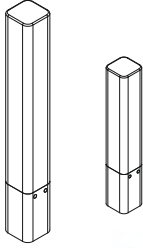

metal / metal

beton / concrete

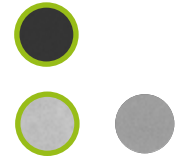

CUS 456



MALZEMELER / MATERIALS

- Açık Gri Prekast Beton, Koyu Gri Prekast Beton
/ Precast grey concrete, Precast Dark grey concrete

YÜZEY İŞLEMLERİ / FINISHING

- Zımparalama / Fine sanding

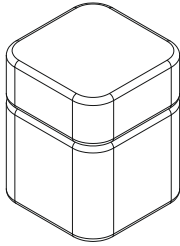
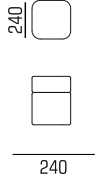
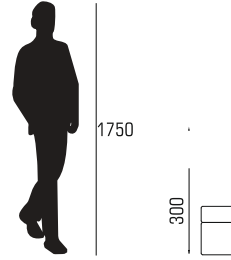

beton / concrete

beton / concrete



CMR P PLAY[®]

O Y U N P A R K L A R I
P L A Y G R O U N D S

CMR V R B A N[®]

K E N T E K İ P M A N L A R I
U R B A N E Q U I P M E N T



FITNESS PARKLARI
OUTDOOR FITNESS
EQUIPMENT



MACERA PARKLARI
ADVENTURE PARKS

CMR RBAN[®]

Kent Ekipmanları / Urban Equipment

📍 Bahçelievler Mah. 430 Sokak No: 16
35375 Torbalı / İzmir / TÜRKİYE

🌐 www.cemer.com.tr

✉ info@cemer.com.tr

☎ +90 232 853 87 04

📞 +90 232 853 97 58

📱 +90 533 385 63 04



www.facebook.com/cemerplaygrounds
www.facebook.com/cemerkentekipmanlari
twitter.com/cemerkent
[instagram.com/cemerkentekipmanlari](https://www.instagram.com/cemerkentekipmanlari)



CMRURBAN is a brand of *Cemer*[®]